

THE S-EIGHTY™

JULY/AUGUST 1980 FIFTY CENTS

Featuring book excerpt...
"TAKE MY COMPUTER, PLEASE!"
from Scelbi Publications



Get your UPPER and lowercase the easy way!



THE PATCH!

Unfortunately, converting your TRS-80* requires installing the video memory chip plus wiring changes. There is only one modification on the market which eliminates most of the wiring. To get the dualcase mod installed you have three choices: 1) Send your computer to a company or individual who will do the wiring, 2) do it yourself, or 3) "THE PATCH".

To make choices 1 and 2 operate requires using software overhead in the form of a "driver". This takes 30 bytes, unless you want a "normal" shift to UPPERCASE keyboard. That takes upwards of 60 more bytes. Software oriented mods have three more disadvantages: 1) They reside in program memory, eating program space which you could be using, 2) other machine language programs are unusable if they are loaded against the top of memory, or 3) the "driver" software MUST be loaded every time you power-up, or the "MEMORY SIZE?" appears due to program bomb. Choice number three suffers from NONE of the software overhead problems. We call it "THE PATCH" and it's new for the 80's!

"THE PATCH", a small electronic module which plugs into the unused ROM socket on Level II machines, makes necessary software changes to ROM supporting lowercase, an optional block cursor, and extra keyboard debounce. Electronically means NO software overhead. Your computer displays lowercase instantly upon power-up, and the keyboard operates in "normal" typewriter fashion.

"THE PATCH" is completely compatible with your TRS-80* since it is the first, and only, TRS-80* lowercase system designed that flawlessly mates with the computer as a unit, not just a special program package.

"THE PATCH" is also the only modification of any kind which can have extra options and updates factory installed for 5 to 10 dollars per option, as they are available. Same day turnaround.

THE PATCH is a trademark of CECDAT, Inc.

*TRS-80 is a trademark of Tandy, Radio Shack Corp.

Call 208-883-0611

Order yours today to avoid extra delay. Send \$59.97 plus \$2.50 for shipping and handling to: CECDAT "THE PATCH", Box 8963, Moscow, ID 83843.

Why Lowercase?

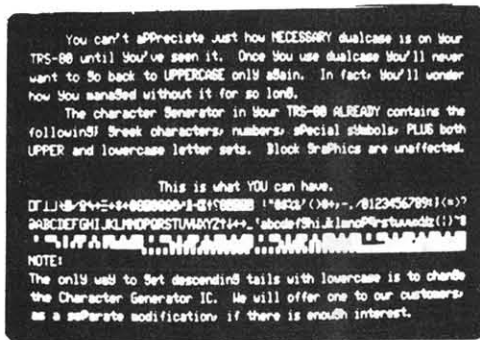

Wouldn't you like to access YOUR entire typeset? Level II BASIC converts lowercase command words into UPPERCASE. All characters contained between quotes remain as typed, but the software in an unconverted TRS-80* allows UPPERCASE display only! This software shortcut allowed Tandy to omit one video memory chip. This chip must be added and the video software repaired before the display of dualcase is possible.

Price increase coming June 1st.

(Print or Type)

Name _____

Street _____

City _____

Zip _____

Master/Visa # _____

Expiration Date _____

Signature _____

___ ea "THE PATCH" 59.97
Ship & Handling + 2.50

___ ea Block Cursor
(Replaces Underline Cursor)

Idaho Residents add 3% Tax

___ Charge ___ Check ___ MO

N/C

Total _____



READER SERVICE L

THERE IS A DIFFERENCE IN TRS-80 DISK DRIVES CAPACITY

Expansion interface – gives your TRS-80 the disk capacity it needs, and much, much more!

10 to 40 MByte, 8" Winchester drive – expands capacity far beyond Model II storage.

Single sided minifloppy – up to 150 KBytes of storage capacity.

Single or double sided 8" floppies – up to 2.5 MBytes in dual drive cabinet – for the serious TRS-80 user.

NOW: ALL DRIVES COMPATIBLE WITH MODEL II

LOBO DRIVES' new family of disk memory products provides you with a choice of memory capacities you need to effectively execute the complex business software you've developed for your TRS-80*. LOBO DRIVES' selection of readily available, software compatible drives permits you to expand your inventory, payroll, customer list, and accounts receivable files as your business grows.

And LOBO DRIVES brings you more... a new plug-in expansion interface that provides an easy way to add hardware enhancements, communications capability, and programmable features... and it comes with the LOBO DRIVES famous 1 year, 100% parts/labor warranty.

Call or write for the complete LOBO DRIVES story. Find out just how competitively priced a family of high capacity drives can be...



935 Camino Del Sur Goleta, California 93017. (805) 685-4546

"CAN YOU REALLY AFFORD TO PAY LESS?"

Quantity discounts available – Dealer inquiries invited

Yes, I want to know more about LOBO Drives and what they can do for my TRS-80. Send me information on:

- 5 1/4-in. Floppy drive
- 8-in. Winchester hard disk, 10 Mbyte drive
- 8-in. Floppy drive
Single sided
Double sided
- Double density expansion interface

Name _____

Company _____

Address _____

City _____ State _____ Zip _____

Phone No. _____

If dealer, provide resale no. _____

*TRS-80 is a registered trademark of Radio Shack, a Tandy Company.

For Your
TRS-
80*

DUAL DISK-32K
 BUSINESS SYSTEM

QUALITY
DTI
PAYROLL

No. 410

DATA TRAIN'S many years of small business computer experience in accounting program products brings to your business all of the quality features, functions, screen displays, standard reports, user designed reports and operator reference manuals; allowing you to efficiently manage the payroll of your company.

- 50 employees per mini-disk.
- Runs in all states.
- You maintain the P/R product without programing.
- Flexible, easy to use.
- No maintenance fees.

\$235.

Product Info &
 License/Order
 Form.

FROM.....



PHONE

(503) 476-1467

840 N.W. 6th STREET, SUITE 3
 GRANTS PASS, OREGON 97526

Available Soon-

- General Ledger Accounting
- Accounts Payable
- Accounts Receivable
- Fixed Asset Accounting

*Trademark Radio Shack, Div Tandy Corp.

THE S-EIGHTY

VOL. 1, NO. 7

INDEX

SUPERMENU Improved
 by James Garon 5

New Products 8

Which Operating System for the Model II
 by Lance Micklus 11

BOOK EXCERPT
 "TAKE MY COMPUTER, PLEASE!"
 from Scelbi Publications 12

NEW LOCATION!
 Reader Service Index 16

Integrated Cassette Control
 by Lawrence E. Whittier 26

S-80 Specialized Software Sources 30

Publisher

Roger Robitaille

Editor

Joseph Breton

Advertising Manager

Mary Reed

Creative Director

Elaine Cheever

Copy Editor

Sheila Jahnle

Production

Lauri Miller

Donna Bennett

Address

The S-EIGHTY
 A SoftSide Publication
 P.O. Box 68
 Milford, N.H. 03055

Telephone

1-603-673-5144

Advertising

Rates

	1x	2x	6x	12x
Full	\$450	425	400	375
Half	\$270	240	225	210
Quarter	\$162	144	135	126

Submissions

Articles, reviews and press releases are welcome and will be published as space permits. No compensation is offered for commercial submissions. Individual authors are compensated at \$20. per page.

*Note: Radio Shack and TRS-80 are registered trademarks of the Radio Shack, Division of Tandy Corporation.

SUPERMENU IMPROVED

by James Garon



Well, it's back to the drawing board! Last April the folks at S-8ighty were kind enough to publish my SUPERMENU program. The response from NEWDOS users was quite favorable, except for a few bemused individuals who reported that the program names disappeared from the screen! We finally traced the problem to the new Radio Shack lower-case modification. It seems that the letters are stored as control codes (ASCII 1-26) for some unfathomable reason of Tandy's. This creates chaos when SUPERMENU attempts to PEEK at the screen in search of program names.

The solution is to add 64 to any peeked value which is less than 32. While I was making the appropriate change (in line 90), I thought I'd add another feature: the ability to see the FREE space on up to three drives. For those of you who have already keyed in the April version, just change lines 30, 50, 90, and 140 and add line 35.

This improved version will work with or without the lower-case mod from the Shack.

IMPROVED SUPERMENU

```
10 SUPER-MENU BY JAMES GARON - DESIGNED FOR APPARAT DOS
20 BASED ON AN IDEA BY DAVE WINTERS
30 CLS:PRINT@17,"* S U P E R M E N U *":CLEAR1E3:CMD"DIR":
  PRINT@787,: :CMD"FREE":PRINT@896,CHR$(31)
35 FORJ=@T064STEP64:FORI=16187+JT0I-59STEP-1:POKEI,PEEK(I-3):
  NEXT:NEXT
40 PRINT@0,CHR$(30)TAB(25)"CREATING MENU":DEFINTH-Z:DEFSTRA-G
50 DIMA(26):L=1:S=15464:P=915:Z=63:PRINT@128,:
60 FORI=@T026:K=I:H=20:R=I-3*INT(I/3):IFR=@H=24
70 S=S+H:IFPEEK(S)=32I=26:L=@:GOTO110
80 FORJ=@T012:M=PEEK(S+J):IFM=32J=12:GOTO100
90 A(I)=A(I)+CHR$(M-64+(M<32))
100 NEXT:PRINTTAB(20+R+5)CHR$(64+I)" "A(I):IFR=2PRINTCHR$(29)C
  HR$(26):
110 NEXT
120 PRINT@0,CHR$(191)CHR$(143)STRING$(60,131)CHR$(143)STRING$(2,
  191): :FORI=127T0959STEP64:PRINT@I,STRING$(2,191): :NEXT:PRINTCHR$(
  188)STRING$(60,176)CHR$(188): POKE16383,191:PRINT@91,"- M E N U
  -";
130 IFK=@PRINT@835,"NO VISIBLE PROGRAMS":FORI=@T01STEP0:NEXT
140 PRINT@899,"SELECTION (@-CHR$(64+K+(L=@))")":GOSUB170
150 PRINT@P,BTAB(32)"STAND BY FOR "A(M):
160 IFRIGHT$(A(M),4)="/CMD",CMDA(M)ELSERUNA(M)
170 Z=206-Z:PRINT@P,CHR$(Z): :FORI=1T010:B=INKEY#
180 IFB=""NEXT:GOTO170
190 IFB<"@DRB>CHR$(63+K-(L=1))THEN170ELSEM=ASC(B)-64:RETURN
```

"THE ORIGINAL"

Personal Computing[®] 80

Presents: Personal Computing and Small Business Computer Show

The Largest Personal Computing Show in 1980

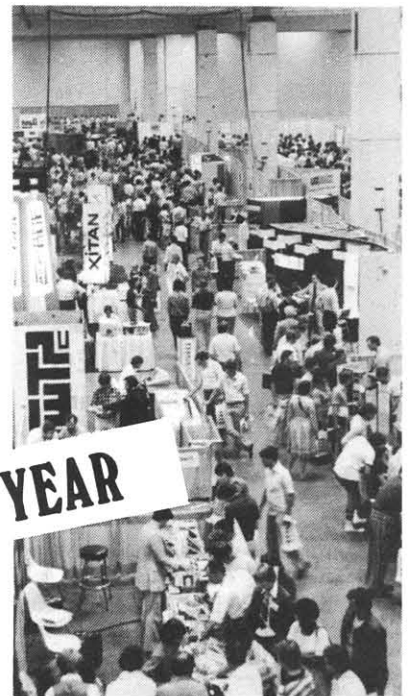
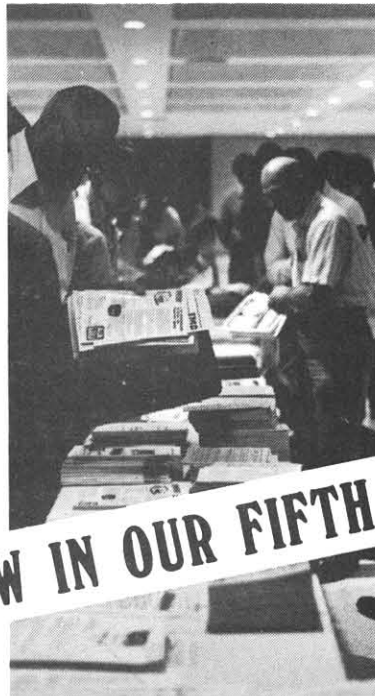
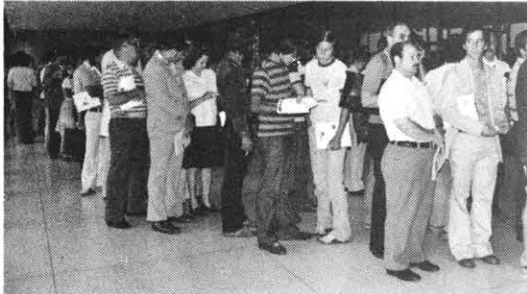

August 21, 22, 23, 24th at the Philadelphia Civic Center

- Major exhibits by the industries leading companies
- Thursday, Aug. 21st, Dealer Day — 12 Noon to 6 P.M.
- Friday and Saturday, Aug. 22, 23rd — 9 A.M. to 6 P.M.
- Sunday, Aug. 24th — 10 A.M. to 5 P.M.
- Free Seminars ● Robotics Contest ● Antique Computer Display
- Special Seminars and Tutorials about Computer Music, Saturday, Aug. 23rd
- 3rd Annual Computer Music Festival, Saturday Evening, Aug. 23rd
(Computer Music Festival is sponsored by the Philadelphia Area Computer Society-Tickets on sale at show)
- Computer Visual Arts Festival, Sunday, Aug. 24th

Advanced Registration Saves Time & Money

Send _____ Dealer-Retailer (4 days) Registrations at \$10. each, \$12. at door for Thursday-Sunday, Aug. 21, 22, 23, 24

Send _____ Regular Registrations (3 days) at \$8. each, \$10. at door for Friday-Sunday, Aug. 22, 23, 24 only.

Advanced Registrations will be mailed late July - early August. No Advanced Registrations accepted after Aug. 8th.

Send Exhibitor information or Phone 609-653-1188

COMPANY NAME _____

NAME _____

STREET _____

CITY _____ STATE _____ ZIP _____

PHONE _____

Send To:

PERSONAL COMPUTING 80

Rt. 1, Box 242, Warf Rd., ● Mays Landing, NJ 08330

THE LEAST EXPENSIVE PROGRAMS YOU CAN BUY.

Up to 77 high-quality programs for
TRS-80, only \$8!

THE \$15.50 COMPILER:

TINY PASCAL FOR TRS-80

At last your TRS-80 can run Pascal too! The Chung/Yuen "tiny" Pascal is fully implemented for Level II TRS-80, 16K and up. You no longer need be left out of the growing group of Pascal users, because People's Pascal gives you everything you need to write structured Pascal programs:

- tiny Pascal compiler
- complete text editor for writing your programs
- complete tiny Pascal monitor
- sample Pascal programs
- user's manual (TRS-80 Computing issue 1:4)

People's Pascal is both a powerful, structured language and "CPU expeditor". People's Pascal programs execute at least four times faster than Basic, and often eight-times faster! Special functions open up the complete graphic capability of TRS-80. You now have the means to write those dazzling, impressive, high-speed graphics programs that are great for games, plotting, statistics, etc.

For the serious computerist, side two of People's Pascal II (tape 6) contains a larger compiler and complete source to the compiler, written in Pascal! This means you can re-compile the compiler, making changes, adding features, etc. (but this will take at least 36 K RAM and a solid knowledge of programming).

With the complete People's Pascal operating system, you can save and load both source (Pascal) programs, and compiled programs, to or from cassette tape. This means that once you have de-bugged a program, you can save the P-code (compiled program) and thereafter, to run the program, you need only load the super-fast P-code.

Here is a partial list of People's Pascal features: recursive procedure/functions • for (loop) • case if/then/else • one-dimensional arrays • write • read constant • repeat/until (loop) • "peek & poke" • plot (graphics for TRS-80)

DEALER INQUIRIES INVITED

People's Pascal 1 (tape 3) is written in Basic, implemented for TRS-80 by John Alexander of Berwick Australia. It compiles P codes more slowly and is harder to use than Pascal 2, but its P codes can be translated into Z80 native code and saved as System tapes. Pascal 2 requires that Pascal be resident at run time—Pascal 1 does not. Other People's Software tapes \$8.

—CA Residents Add 6 per cent TAX (\$8.45, \$16.40 & 24.88). Quoted Prices INCLUDE \$.50 Shipping—

TAPE 1 LEVEL 2

Mortgage calculations, Dow Jones Industrial, cash flow, inventory-change, California income tax, journal ledger (8K), loan amortization, perpetual calendar, bio rhythm, payroll, diet planning, speed reading, touch typing, sales receipt tally, decision maker, mail addressing, straight depreciation, double-declining depreciation, and revolving charge account.

Also, math problems, queen, Star Trek I, number guessing, wheel of fortune, World War II bomber, rock-scissors-paper, seek, Star Trek II, Red Baron, mini-Trek, strategy, pilot, battleship, "On A Snowy Evening", mastermind, tic-tac-toe, grand prix auto race, capitals, etch sketch, hangman. Total programs: 34; Level 1 version available: 24 programs. \$8.

TAPE 2 Some Common Basic Programs (lev. 2)

Fully documented in *Some Common Basic Programs* by Lon Poole & Mary Borchers (Osborne & Associates, 630 Bancroft way, Berkeley, CA 94710—or from CIE—\$12.50 postpaid from CIE, via UPS, CA residents add tax (to \$13.25)):

Investment, future value regular deposits; regular deposits; regular withdrawals, initial, minim (for withdrawals); nominal interest, effective & earned-interest; depreciation rate, amount depreciation; salvage value; discount com'l paper; loan principal, regular & last payment, remaining balance, term-loan; mortgage amortization; greatest common denom.- integer prime factors; polygon area; triangle parts; analysis, operations two vectors; radian-degree., degree-radian conversion; coordinate, polar equation, functions plot; linear, curvilinear interpolation; Simpson's & trapezoidal rules, Gaussian quadrature integration; derivative.

Side 2—quadratic equation, polynomial (Newton) & half-interval-search roots; trig polynomial; simultaneous equations; linear programming; matrix addition, subtraction; scalar multiplication, inversion; permutations & combinations; Mann-Whitney U test; mean, variance, standard deviation; geometric mean & deviation; binomial, Poisson, normal, Chi-square distribution; Chi-sq., student's T-distribution test; F-distribution; linear correlation coefficient; linear, multiple-linear, Nth order, geometric, exponential regression; system reliability; future projections; Federal withholding taxes; tax depreciation schedule; check writer; recipe cost; map check; day of week; days between two dates; anglo to metric; alphabetize. \$8

TAPE 3 People's Pascal Development System 1

Pascal 1 compiler-program development system. \$15.50

TAPE 4 LEVEL 1

Election returns, business percentage, ups and downs of business, index, inventory control, sales receipt tally, gas mileage, driving distance, mixed monthly sales report, payroll, annual earnings, speech recording aid, and double-declining depreciation.

Also, math problems, cash register, chase, snoopy, commander-in-chief, Christmas graphic, air raid, balance scale, stock market, tic-tac-toe and On A Snowy Evening. \$8

TAPE 5 LEVEL 2

Memory test, mortgage payments, tension breaker, lineprinter-screen & vice-versa utilities, Federal income tax, election returns, business percentage, vacation planner, car pool(disk), diet planning 2, mailing list(disk) and first aid.

Also spelling bee, Star Trek 3, mind bender, tachistoscope, chase, common factor, klingon capture, spelling practice, Hamurabi, animals, Snoopy, cryptogram, starship, ants, Yesterday, and Pilot(disk). Pilot is the language of computer-aided instruction (CAI).

TAPE 6 People's Pascal 2

Pascal 2 compiler-program development system. \$23.50

TAPE 7 LEVEL 2

Disassembler, Pilot, roster, dropout, memory loader, memory sort, inventory control, graph, land surveying, mixed monthly sales report, shopping list, diet planning 3, loan progress chart, hex-decimal conversion.

Also Star Trek 4, states and capitals, battleships 2, spelling practice 2, number guessing, hangman 2, snark, slot machine, cipher, target, surround, adder, termites, lunar lander, multiplication exercise, five-in-a-row, Bastem, and write. A number after a program indicates there are other similar People's Software programs. Pilot is the same as the disk pilot on tape 5, except runs on 16K tape systems. \$8.

COMPUTER INFORMATION EXCHANGE
Box 159, San Luis Rey CA 92068 (714) 757-4849

New Products

The S-EIGHTY is happy to publish information about new products related to the TRS-80*. We cannot be responsible for the accuracy of the information presented here, and those with questions are asked to contact the indicated companies directly.

*Trademark of Radio Shack Div. of Tandy Corp.



THE COMPUTERS THAT SAVED METROPOLIS

"The Computers That Saved Metropolis," a new Superman comic, combines easy to read factual information on microcomputers with a typical Superman adventure.

The full-color book is available for free distribution to schools, clubs, youth groups and interested individuals from participating Radio Shack stores and dealers, nationwide.

According to Radio Shack, the booklet has been designed as a motivational learning aid for young people, offering a new approach to building interest in reading as well as in computer science.

Included within the comic book are coupons which may

be used to request additional copies, copies of "The Science Fair Story of Electronics," a membership in Radio Shack's free battery club, and a \$1 gift certificate that can be used toward the purchase of any Science Fair or Archer kit at participating stores.

In recent years, Radio Shack has distributed more than 15 million copies of the educational comic book "The Science Fair Story of Electronics," which is said to have found wide use as an educational tool.



POWER LINE INTERRUPTER

ELECTRONIC SPECIALISTS announces the introduction of the POWER LINE INTERRUPTER. Should AC Line voltage be disrupted or exceed USER selectable limits, the POWER LINE INTERRUPTER disconnects power from controlled apparatus. Front panel controls provide UNDER/OVER voltage interrupt level selection and Power Reset. Other features include integral Spike/Surge Suppression and response delay to prevent false interrupts.

Intended for specialized MicroComputer applications, where equipment is subject to periods of unattended operation, the POWER LINE INTERRUPTER will provide safety and protection for equipment as well as personnel.

Connecting to the AC line with a standard three prong plug, the POWER LINE INTERRUPTER can accommodate a 15 amp resistive load or a 10 amp inductive load.

Model PI-15-O/U OVER and UNDER—VOLTAGE \$142.95

Model PI-15-U UNDER-VOLTAGE only \$127.95

Electronic Specialists, Inc., 171 South Main Street, Natick, Mass 01760. Phone (617) 655-1532.

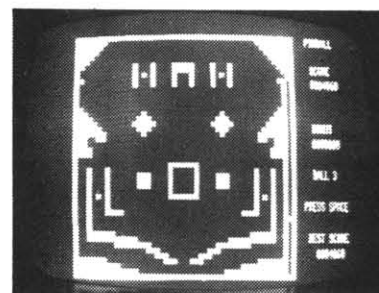

PINBALL

Acorn Software Products, Inc. announces the release of PINBALL, a real-time, arcade game for the Radio Shack Model I Level II TRS-80 written in machine language.

PINBALL includes flippers, bumpers, rollovers, runs, bonus points. The space bar on the TRS-80 releases the ball at various speeds under player control. Once in play, both the speed and acceleration of the ball depend on the contact with various features on the board, including the mysterious "Bermuda Square." As with any pinball game, the player must develop skill with the flippers to get maximum points and playing time.

PINBALL is priced at \$14.95 on cassette, or \$20.95 on disk. Dealers should direct their inquiries to: Acorn Software Products Inc., 634 North Carolina Avenue, S.E. Washington, D.C. 20003 or phone (202) 544-4259.

MORSECOPY

An extraordinary program of interest to radio amateurs has recently been introduced by The Peripheral People. The software, called MORSECOPY, can be used to replace hardware costing several hundreds of dollars.

Written for the TRS-80 MORSECOPY translates incoming code (applied to the cassette CLOAD plug) and displays it on the screen. No hardware is required for VHF modulated CW transmission. Audio which exceeds the threshold level of the TRS-80 cassette input is passed for translation and screen display or hard copy printout. A simple audio filter (using

either 88mH toroids or an operation amplifier) is required to separate interfering signals on the HF bands. Either circuit can be easily constructed by radio amateurs.

MORSECOPY will translate and display transmissions up to 35 WPM if the cassette load modification has not been incorporated by Radio Shack. The installation of this modification will slow the translation speed slightly.

The program can cope with minor changes in speeds and has "catch up" provision if the sending speed is significantly increased and decreased. Copy from electronic keyers is excellent.

MORSECOPY is available on cassette or diskette (specify) and is priced at \$29.95 including first class postage.

For additional information, contact Lucy A. Stoner, The Peripheral People, P.O. Box 524, Mercer Island, WA 98040, 206-232-4505.



#9 GHOST TOWN

Here's great news for fans of Scott Adams' Adventure computer games series - there's a brand new one on the market, and it promises to be even more challenging than its predecessors.

"Ghost Town" was begun last December, and is just now ready to baffle, confound and perplex armchair gamesmen. It is, says Adams, even more complex than his other adventures, and involves runaway horses, gold mines, venomous vipers and savage Indians. Collecting the game's thirteen treasures

and avoiding all the perils present a challenge for the old hand at Adventure games, but this new one has an additional twist — in order to conquer the game completely the player must also accrue 50 bonus points. That's the tough part! Also, the "helps" have been eliminated, so prospective gamesmen — even veterans — shouldn't expect to breeze through this one.

"Ghost Town" is a complement to Adams' nine other Adventure computer games, all of which have received a phenomenal reception from armchair adventurers all over the U.S. Your local dealer or mail-order house has number nine now!

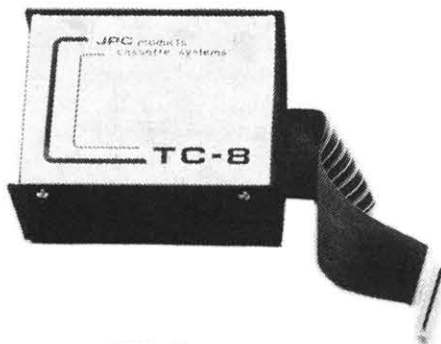

TC-8

JPC Products Company announced recently that they have developed a new High Speed Cassette System for the Tandy TRS-80 Level II computer. This Cassette System is based upon the very successful and widely acclaimed TC-3 which was developed three years ago for the M6800 computers.

The system, which some users have nicknamed the "Poor Man's Floppy", allows the TRS-80 user to load programs five times faster, using the present cassette recorder, and it provides much better reliability than the TRS-80 system. While running at over 3000 Baud, you can expect less than one bad load in a million bytes with the volume control anywhere between 2 and 8.

The TC-8 (JPC Products' name for the cassette interface) and its software give the TRS-80 user a complete High Speed Cassette System. It supports the saving, loading, and verifying of BASIC programs, system programs, and

data files. Features of this Cassette System include eight character named files, the ability to list the directory of all files on a tape, verification of saved files, and a far more efficient data file storage technique which closely resembles that of a disk system.

The TC-8 comes with an extensive users manual (over 50 pages) and a unique (almost unbelievable) kit builders guarantee: "If you build the TC-8 and for any reason it doesn't work, we will make it work at NO COST".

The TC-8 is available in kit form at \$90.00 and fully assembled at \$120.00 from JPC Products Company, 12021 Paisano Court, Albuquerque, New Mexico 87112. Telephone (505) 294-4623.



WHICH OPERATING SYSTEM FOR THE MODEL II

by Lance Micklus

Although a lot of people have tried to generate some interest in getting Model I users to use CP/M, it just never caught on. Most people seemed to feel that between TRSDOS, NEWDOS, and VTOS, there was plenty of operating system there and no real advantages to using CP/M. Because, just about all the original TRS-80 software was written for TRSDOS, and a Model I CP/M would be a step-child. Why, then, all the interest in CP/M for the Model II?

First of all, the Model II is an ideal CP/M machine. There is no ROM in the bottom of memory. It uses 8-inch double density disks. Has a true 64K of RAM. And a nice set of I/O ports. Plus, the Model II is Z-80 based so it will run any CP/M software as well as the perfect screen format of 80 by 24.

Model II TRSDOS is a bastard. Its creator seems to have had no more experience building a micro-computing operating system than I do. It is a one-of-a-kind, with no software to really support it. Unlike CP/M, which has been in the field for several years, Model II TRSDOS is new code which still has many problems.

It would almost seem that CP/M would be the logical choice. But, let's take a closer look at these two operating systems to see if it still looks that way when we're done.

Model II TRSDOS has one big advantage over CP/M. It's FREE. It is included in the cost of the computer. And, even if it wasn't, Radio Shack sells extra copies of it for \$25.00. Part of your free TRSDOS includes a very powerful Microsoft Disk BASIC, plus a couple of handy little utilities like TERMINAL whose features have some resemblance to another terminal program I've used myself, from time to time.

CP/M from Lifeboat will cost you \$170.00 plus shipping charges. It includes no BASIC. An equivalent Disk BASIC is probably Microsoft's Level IV BASIC. But, now, Lifeboat is pushing BASIC-80 and MBASIC. Just to use some nice round figures, that adds up to about \$600 for a CP/M operating system, and a BASIC that's better than the one Radio Shack includes. For \$600.00 people can learn to live without a lot of things, including PEEK and POKE. Maybe TRSDOS will win on the basis of price.

Not necessarily. The typical Model II computer is bought for around five to six thousand dollars whereas the typical Model I computer is bought for less than a thousand dollars. I don't think the Model II user is going to be that concerned about \$600.00 if he can justify the purchase. For the answer to this, I think we have to look at why the Model II user bought the machine in the first place.

The typical Model II user's first consideration was the storage capacity of those nice big 8-inch double density disk drives that total up to around two megabytes. Secondly, he is going to use the machine in some type of serious application, such as doing accounting for his small business. He doesn't want a toy, but a real computer that's reliable and easy to use.

TRSDOS' super storage capacity is not what Radio Shack would like you to believe. Sequential files can only store around 65,000 bytes. Random files typically can be larger than the capacity of the disk. CP/M files can be 8-megabytes in size regardless of whether they are random or sequential files. If disk capacity was a prime consideration for purchasing a Model II, then CP/M offers more disk storage.

I don't know about you, but I can blow up my own disks without Radio Shack's help—thank you. Yet, TRSDOS has a number of problems which can permanently damage the data on a disk. First, you must always tell the operating system when you change a disk. Failure to do so can result in gross directory errors. Secondly, in case you hadn't read the small print, a disk full error is fatal. Radio Shack simply suggests you rerun the job with your backup copy after deleting some files to make extra storage space.

In the world of business computing, your data disks are precious. Anything that threatens their integrity is a problem that must be dealt with, no matter what the cost. If you can not rely on your computer, then it is worthless. Have I justified \$600.00 yet?

CP/M, on the other hand, seems to be very forgiving. So long as the files are all closed, you can change a disk without ever telling the operating system. CP/M will not destroy a directory when the disk gets full. True, you'll still have to rerun the job, but the data on the disk should still be good.

Of the two operating systems, TRSDOS is the easier to use. But only at first. CP/M is harder to learn, but, once you get used to it, you'll find it just as easy. There's a very good reason for this.

CP/M comes with some good technical documentation. But, to the typical Model II user, I imagine it's all Greek. You get several little books, all of which look complicated, and you don't know where to start. Wisely, Small System Software, which did much of the work for Lifeboat to make a Model II version of CP/M, included one additional book. Judging from its title, you might suspect that it is a good place to start. It is. The book tells you in plain English how to load CP/M, and then how to back it up. That's a very good way to begin. But after that, things get muddy again because you don't know where to go next.

The answer is to forget about the other books and read "AN INTRODUCTION TO CP/M FEATURES AND FACILITIES". Chapter 2.1 gives you the 5 commands that CP/M understands. Except for the SAVE command, you will need to know all of them. Next, learn the syntax for file names under CP/M. Specifically, drives are referred to by letters, not numbers. The file name and optional file extension are separated by a period instead of a slash. There are no passwords in CP/M.

Chapter 5 explains what the different control keys do. And here is one of the weak points of CPM. Unless the software house that implemented CP/M for your computer provides you with the

information, the obvious may not be grasped. For example, the [BREAK] key and CONTROL-C are the same. Or, for that matter, how do you send a control character? A lot of Model II people never used a computer before. They don't know that to send a CONTROL-Z, you press the button marked CONTROL down and hold it down while you press the letter Z. You should also know about CONTROL S.

The next chapters in the book cover the standard CP/M utilities. There are two you should learn to master quickly—PIP and STAT. Finally, you should play around with CONFIG.

CONFIG is not a standard CP/M utility. CP/M is a very flexible operating system and is designed to be customized. This includes the ability to easily implement your own printer drivers, serial I/O, etc. Suppose you have a serial printer. Normally, you would have to write your own machine language subroutine to allow you to use it with CP/M. This is not something that the average Model II user would want to do. CONFIG was written by Small System Software and it takes all of the work out of modifying CP/M to fit your particular hardware requirements. This is an easy to use, menu-driven program that lets you just tell CONFIG what you want changed, and it changes it for you. No machine language code to write—just select 1 to 6. In my judgement, CONFIG just might make enough of an improvement to the typical CP/M package to make CP/M acceptable, over TRSDOS, to the Model II user. Otherwise, CP/M could begin to get too complicated.

With these commands at your finger tips, you now know enough about CP/M to start using the system. With a little experience, the other features and facilities can be added to your repertoire of commands later.

TRSDOS is set up to be much more user-oriented. The manual is not technical; it is written for the first time user who never operated a computer before. It's very clear where you should start reading because the section is marked "INTRODUCTION".

TRSDOS commands are much more straightforward. DIR, for example, shows you every file on the disk with all of the information about each file. One command does it all. CP/M will do that too, but not with one simple command. Instead, you use one of the STAT commands to get the same type of directory listing. Which means that you have to know how to use the STAT utility program. In other words, in TRSDOS, all you have to learn is a command. With CP/M you have to learn how to use an entire program.

CP/M commands seem to be more powerful. Wild cards let you list or copy a specific group of files. One trick I learned was to try to name a particular group of files with the same first two letters, like CB for all of my CBASIC files. I can now move all of my CBASIC files from one disk to another with the command:

```
PIP B:=CB*.*
```

which copies all of my CBASIC files, and only those files, from disk A: to disk B:.

Here's a perfect example of what I'm talking about. Let's say you want a hard copy listing of your directory. There's an option in the TRSDOS DIR command to make that happen. The option is explained in the most logical place, with the des-

cription of the DIR command. To do the same thing with CP/M, you have to learn to use the STAT program, which only lists the directory to the screen. Then, it would have to occur to you that CONTROL-P causes all output to the CONSOLE (or screen) to also be printed on the line printer. That feature is explained in Chapter 5, where they talk about line editing functions—which has nothing to do with listing directories. On the other hand, I think you can see how much more powerful CP/M's CONTROL-P is when compared to a single option in TRSDOS' DIR command. This, I think, pretty much tells the story of the differences between the two operating systems.

Supposedly, another advantage to CP/M is the wealth of software that already exists for that operating system. In general, most non-TRS-80 software comes out on CPM first. MBASIC is a good example. Then, if there is a market, the software is also released in a TRS-80 version. Just look at any of Lifeboat's SHOPPING LIST ads and you'll see a lot of software you can't get on any TRSDOS operating system—like PASCAL-Z.

Finally, CP/M software tends to be very general purpose in its implementation. Whereas the equivalent type of software which was written on a TRS-80 is more likely to take advantage of those features which are supported on that machine, especially graphics.

One other area to consider is distribution of application programs. There is no easy way to distribute programs on TRSDOS, especially for single drive users, since the operating system needs to be included on the disk. Since TRSDOS is copyrighted, the only legal way to do this is to have the user send in and register his copy of TRSDOS, so that, in theory, you can return his software to him with his own operating system on the disk.

CP/M handles the one drive situation fairly well. Unlike TRSDOS, CP/M does not use overlays, so it need not be present on the disk at all times. Small System Software very wisely added a couple of their own utilities that enhance the operation of CP/M even further for the single drive user. This means that distribution under CP/M presents no problems since the disk need not contain Digital Research's code.

But, if the software people don't tip the scale over to one side or the other, then the hardware people might. I wonder how many people have looked at that disk drive connector on the back of the Model II, and said "Gee. There must be a way to directly hook up a 20-megabyte drive." CP/M likes 20-megabyte drives. But with TRSDOS you'd have to come up with a set of patches which will change each time Radio Shack comes out with their latest version of Model II TRSDOS.

Personally, I happen to prefer CP/M over the Model II TRSDOS. I can get a lot of CP/M software that is unavailable under TRSDOS, such as PASCAL-Z. It's much easier for me to write application programs under CP/M than it is under TRSDOS. I have found TRSDOS to be extremely difficult to work with at the machine language level. But most important to me is the fact that Lifeboat acts like they really want CP/M to be THE OPERATING SYSTEM for the Model II.

TAKE MY COMPUTER, PLEASE!

"This article is excerpted from *Take My Computer, Please!* Copyright © 1978, SCELBI Publications, 20 Hurbit St., Elmwood, CT 06110. All rights reserved"

"Ken, you gotta help me!"

The feeling of panic was coming over me as I beat on Ken's back door. I needed help and Ken was the only person I could trust - the only person that would understand that I wasn't crazy. As I knocked on the door, I glanced over either side of my shoulders to make sure no one else was around.

"Ken, you gotta help me!"

I stood next to the door in a shadow which the moonlight failed to illuminate. It was a cool spring evening. While the stars shown brilliantly in their quiet elegance, I couldn't help but fear that this would be the last quiet moment of the evening if I failed.

"Steve? What are you trying to do? Can't you just ring the bell and wait thirty seconds like everyone else?"

Ken wasn't really mad, just startled at my wild-eyed look and disheveled appearance. I often visited him but usually announced myself by some means other than beating down his back door. He waited a few seconds. He realized that this wasn't a social call and changed his tone to one of concern.

"What's wrong? You look terrible."

"I locked myself out!"

For any other person in the world, that would not be a catastrophic occurrence. In fact, the words sounded a bit absurd as I said them. I only hoped that Ken valued our friendship enough to listen to me before throwing me out.

"You locked yourself out? Didn't you once give me a key to hold just in case this ever happened?" Ken was becoming increasingly curious as to why I should be so distraught. I should have known he had a key.

I nervously glanced at my watch and answered, "That was when one needed a key to get in my house." Such a statement obviously would lead to all kinds of conjecture but I didn't have time to explain.

"What do you mean, no key? How do you get into your house? Whistle?" Ken seemed a bit disturbed that I was playing guessing games.

"I don't use a key anymore. I use a digital code like a credit card. I really don't have time to explain. Please, just put on some dark clothes and help me."

His help-thy-neighbor attitude took five giant steps back when I mentioned the necessity for dark clothes. Glancing at my watch once again to see how much time we had left, I determined that a portion of it had to be allocated for explanation. I stepped into the doorway and moved past Ken.

"You see, Ken, I've locked myself out of the house and I have a souffle in the oven. My wife is off visiting her mother, so she can't get here in time."

Ken looked at me like I was some kind of nut. He walked over to the kitchen sink and opened the cabinet doors beneath it, revealing a toolbox. Before He could pass me any tools, I interrupted him. "Ken, it's not that easy. You don't understand. Let me explain."

The expression, "Please do," was painted all over his face and needed no verbalization. As he sat down in the overstuffed chair, he extended and crossed his legs on the footstool. To further the

impression that he was ready for a real fish story, he took out a briar pipe and nonchalantly started to clean it. Between the sounds of tapping the pipe on the ashtray and blowing through the stem to clear it, he extended his hand towards me and said, "Do begin, please."

The delay was excruciating. It was critical to act soon. The souffle was irrelevant. It was the chain of events which could be accidentally touched off that I was worried about. My only hope was to talk fast.

"Ken, my house doesn't use a house key anymore because it has a computer-controlled digital alarm system!"

He puffed on the pipe and interjected, "Fair enough. But what's that got to do with the souffle?"

"This isn't just any digital alarm system. I designed it! An advanced sensor system tied directly into my computer makes it about the most sophisticated home buglar alarm in the world. I got thinking one night that I needed a burglar alarm and the computer did sit there doing nothing most of the time. It was only natural to consider using it. But I got a little carried away on the engineering and I'm not sure I know how to get in without setting it off."

Ken was amused. Every time he and I had spoken lately it had something to do with computers. He no longer thought I was completely crazy, just a little. There was still that one burning question, "What has that got to do with the souffle?"

"If it was just a case of waiting for my wife to bring the coded card home, there wouldn't be any problem. There's a souffle in the oven and let's see...it should be done in thirty minutes. But the oven timer isn't set to shut the oven off. I know you're only a civil engineer and not Betty Crocker but even you can guess that it wouldn't be more than another twenty to thirty minutes before it starts to burn."

I spoke rapidly. We were eating up precious seconds. "When the smoke from the burning souffle hits the smoke detectors on my alarm system, all hell is going to break loose on this street."

"Wow! What does it do, call the police?"

Most people were familiar with the standard smoke and burglar alarms which automatically dialed the fire department. While the end result was the same, the method was quite different. The sophistication of a full-blown computer was unmatched by anything that commercial companies had to offer. That, in combination with the mind of your average, everyday mad scientist can produce startling results.

"Well," I started rather sheepishly. It isn't often one has to explain the limits of their paranoia. "It isn't everyday you have a fire in your house. When you do, you want action fast so you can reduce the damage and get people out in time. This system is predicated on everyone acting fast. When a fire or smoke is detected, it first sets off the alarm horns mounted outside next to the garage. I've never tried them but they're war surplus air raid sirens.

"Mathematically, the sound level coming out ought to be high enough to break about half the windows on the street. Mrs. Picker, who lives directly across from my house, will probably have

her whole house moved back about two feet when they go off.

"Secondly, there are four aircraft landing lights mounted on the corners of the house that will start flashing with about two million candlepower each. That was just in case the fire trucks had trouble finding the house.

"Then come the automatic telephone calls. Remember, Ken, my computer has a voice synthesizer, so I don't need a tape recorder. It definitely doesn't sound like a recording. The first call is to the fire department. It also is simultaneously transmitted on CB channel nine. Then a whole bunch more. The end result is more cars and trucks than we can fit on this street."

The pipe in Ken's mouth dropped lower and lower as I conveyed the consequences of my alarm going off. It was hanging down to his chin when he muttered, "Why don't you add me to the list of calls in case I miss the initial shock wave."

"Don't worry, Ken! You're the ninth call!" Ken definitely had a concerned expression. As I expanded upon the next step, it turned to terror.

"Ken, you gotta help me break into my house and shut the alarm off before the souffle burns."

The pipe fell out of his mouth and the ashes formed a line down the front of his shirt. He barely noticed them as he exclaimed, "Are you crazy? Break into your own house?!"

"Look, Ken, I designed that system to prove I could do it. Now that I can count the seconds before I know it's going to go off, I recognize it as pure overkill. I'll replace it later with something more sane, like six Doberman pinschers and a minefield. But right now we have to stop it! Will you help me?"

Ken brushed the ashes off his lap and jumped up.

"Do I need dark clothes?"

"Yes, I'll explain later. And wear a sweatshirt with a hood or something to cover your head."

The evening newspaper fell to the floor as it was sucked off the table by the vacuum created as Ken ran to change. I could detect a cold sweat forming as I checked my watch repeatedly. It was only ten minutes since we had first started talking but now it was only twenty minutes before the souffle would be done.

I could picture in my mind the progression of events that would follow. First, the souffle would blacken and crack. Then, as it shrivelled, some of the exterior sections would have dried enough to be combustible. The first whiffs of smoke would go unnoticed but eventually a billowing cloud would spew forth from the oven. When it reached the smoke detectors, the computer would go into action. Our only hope was to get inside in time to stop the computer. If we failed, we had better make sure we were not standing next to one of those sirens when it blew. Further thoughts were interrupted as Ken burst into the room fully dressed for action.

"I'm ready, let's go."

Ken looked like a cat burglar. The solid black sweatshirt had a hood which completely covered his blonde hair and, while his reddish beard still showed, it aided the camouflage. His pants were equally dark and skin tight. All reflective surfaces such as belt buckles and key chains were carefully omitted. Black track shoes completed the outfit. I only hoped we didn't have to do too much running with all the rope and tools.

As we jogged up the street toward my house, Ken turned and asked, "You sure you know how to get in?"

The details of the computer alarm design flashed through my mind. I knew every wire, every sensor. Yes, I knew what the components of the system were. But the computer had far greater speed than I at analyzing the data received from them. A pressure switch activated in the wrong sequence, a heat sensor detecting human presence, any number of things could activate the alarm. I had let my inventive genius run "open loop."

the tiny credit card which now lay on the coffee table in the living room had been my only control over the potential Frankenstein that I had created. True, it would foil a burglar or call the fire department, but the ends to which I had gone in devising the system were aimed more at instant incineration of any perpetrator than protection of property.

To fully answer Ken's question was impossible. I didn't know whether I could beat myself at my own game. "I don't know, Ken, I hope so."

We stopped in front of my house. Music could be heard from inside. A light in one room switched off and another turned on. I didn't wait for Ken to ask since I knew he was curious.

"The computer knows no one is in the house, so it is simulating it by playing music and making it appear as though people are moving from room to room. Most of the AC outlets in the house are remote controlled. The computer can control almost any light or appliance in the house, except the stove."

Ken started toward the front walk. I grabbed his arm to stop him.

"Forget it. The only way into the house is through some window that doesn't have any sensors attached. They're in the back of the house. Possibly one of the bathroom windows would be best to try."

"Hey, Steve, before I lay my life on the line to save your souffle, do you mind telling me what happens if we set off the burglar alarm while trying to break in. You already told me about the fire alarm."

My reputation had preceded me. The fire alarm was only part of the system. The burglar alarm was equally as devastating.

"Well, there's a bunch of stuff I'll explain as we go along. It's too complicated to explain in detail. But the end result is that the computer determines the location of the perpetrator and tries to lock him in the area where he has been detected and calls the police."

"If that's all, you can explain the accidental phone call to the police. They often get false alarms from automatic dialers."

"Wait, you didn't let me finish. Then, it sets off all the sirens and lights, just for good measure. And, oh yeah, there's a very loud noise source inside the house that's triggered which is supposed to temporarily disable the perpetrator. Then it does all the same telephone calls, explaining there is a break in instead of a fire."

Ken looked at me in amazement. The adventurer in him wanted to go full speed ahead and tackle the Mount Everest of electronic obstacle courses while the same quiet civil engineering instinct suggested that he go home and check his medical insurance first. He shook his head as he said facetiously, "Why didn't you just use tear gas."

"Oh, I considered it. It's just too hard to get the smell out of the Oriental rugs."

This unexpected response was too much for Ken. As we stood there in the moonlight, I could see the sweat forming above his brow.

To this point, he had been aiding an eccentric neighbor. Though it had taken a long time and not through any direct explanation, Ken was ready to admit that this computer alarm had to be stopped. There was no animosity that I had created it, just a realization of the full consequences of its being.

He, too, looked at his watch and sensed the seconds ticking away. No longer was he along for the ride. Now he was a committed participant. "Let's go."

I knelt down next to a sandy area at the corner of the lot. Ken looked over my shoulder. Grabbing a short stick to draw in the soft soil, I started to lay out the attack plan, "Here's the house, the property line, and key obstacles. There's only one way to approach the house from the rear and not be detected. We have to go over the side yard fence, along through the brush to the pine trees behind the house, and then across the back lawn. Have you done any pole vaulting recently?"

"Pole vaulting? Are you kidding? I just about have enough energy to go from the couch to the refrigerator for another beer. What are you talking about?"

His eyes opened wide and projected a common expletive. The general translation was, "Hey man, I agreed to break in a house with you, but I ain't pole vaulting over no fence."

That was the easiest way, but I had to agree with Ken. The years in the cellar being a mad inventor rather than a tennis pro had taken their toll. I wasn't about to pole vault over any fence either.

"We've got to find a way over the fence without putting anymore than fifty pounds of weight on it at any time. There are strain sensors in the vertical supports which are meant to detect anyone climbing over it. Tripping it won't set the whole alarm off but it will start a three minute timer. After that it will go off if you don't type in an abort code indicating a false alarm."

We stood next to the fence. It was constructed of heavy wire mesh attached to metal supports. Trying to vault over such a fence and missing would be like putting your body into a cheese grater. The thought made me shiver. It was only about five feet high though, so there had to be an easy way over it.

Ken looked at the situation. I could see his civil engineering brain going to work. Pictures of levers, fulcrums, balances, pulleys, and other tools of the trade were flashing through his mind. It was ironic that we stood there about to use the talents of one engineering regimen to counteract the creation of another.

Walking over to the tree adjacent to the fence, he started coiling a length of rope in one hand. With one mighty swing he threw the coil of rope over a twenty foot high tree limb hanging directly over and parallel to the fence. Now the rope hung down and touched the top of the fence.

"Come here, Steve," he said.

I was still a little puzzled, even as he looped the rope around under my arms and tied a knot at my chest. Only when he pulled on the other end and hoisted me off the ground did I realize how he intended to get us over the fence.

"Gee, Steve, why don't you lose a little weight for the next break in?"

I felt like a side of beef hanging on a rope six feet off the ground. When he started swinging me from side to side, I thought I was going to get seasick. The amplitude of the swing got longer and longer until the arc carried me over the fence to the other side. The realization of what the next part of the sequence would be came a fraction too late for me to protest. As the arc carried me over the fence, Ken let go of his end of the rope. Logically, I should have expected that this was the only way, but the experience of being swung on the end of that rope hadn't any semblance of logical reasoning on my part. My far too late protest started something like a "whoop" and concluded with the tonal equivalent of Tarzan merrily swinging through the jungle and suddenly missing the last vine.

The fall was only six feet but it felt like a hundred stories. I thought that if that was a sample of things to come, maybe I should take my chances with the alarm. It didn't help matters when I landed sitting down. The ground was quite moist and my clothing sucked up the water like a sponge. When I put my hand down to reorient my position, I felt the cold, spring mud ooze between my fingers. The totality of my situation and the immediate sensations at hand were summed up with the single word, "Yech!"

As I turned to check on Ken, I caught a glimpse of him sailing through the air. Rather than be hoisted, he had secured one end of the rope and tied large knots in the other to aid climbing. Once at the six foot level, he swung out over the fence as I had and let go. Even though he came down feet first, the momentum was too great for the terrain. It only took a fraction of a second for two skid marks to form behind his heels and Ken came crashing down in the same sitting position next to me. His first word was, "Yech!"

I glanced at my watch and realized there were only ten minutes left on the oven timer. I said, "Come on, Ken, we can't sit here like two idiots. There's not much time left. We have to head for the brush on the right and then crawl towards the pine trees."

"Crawl? Why do we have to crawl?"

"I'll explain when we get there. Right now, pull your hood up over your head like this. Whatever you do, don't look at the house as you run past the brush into the pines or the computer will see you."

"What is this, a science fiction movie or something? What do you mean see us?" Ken's nervousness was evident by the shrillness of his voice. He should have believed me when I said it was the most sophisticated alarm installed in a home.

"Just that. See that small box on the corner of the porch roof?" I pointed to a small black rectangular enclosure suspended below the corner of the roof line. About every ten seconds a small red light flashed, giving it the appearance of being activated.

"There's a digital television camera in that box which scans this section of the yard between a height of three feet and seven feet. When that light flashes, it starts a scan and looks for changes in light patterns from one scan to the next. With our dark clothes, by running just ahead of the scan we should go unnoticed."

The thirty seconds it took while we watched the blinking light until we could anticipate the next scan seemed like an eternity. When the precise moment

came, I yelled, "Head for the pines. Go!"

Running with both hands in our pockets to shield our skin from detection made trying to run at full speed rather awkward. It was more like a high speed waddle than the statuesque gait of a long distance runner. We had five seconds to make it to the pines before the camera would start to retrace its path and compare the new image to that of the preceding scan. It was barely 120 feet, but it took all of our effort to achieve it in time.

As I was about to dive under the first pine for concealment, I remembered something vitally important. I crouched under instead. "Ken, watch out where you walk. This is where my dogs do their business. Oh, I see you just found out. Sorry about that, Ken."

Ken was apparently just mentally chalking it up on his list of reasons to strangle me when the escapade was over - which it wasn't. Standing out there in no man's land was not accomplishing the task. Pointing to his watch, he said, "We have five minutes. What's this about crawling?"

"Don't worry about it, just crawl. Remember, don't stand up or we're dead. Ready? Go!"

Ken still didn't understand why he was on all fours, crawling towards my house at ten o'clock at night. Life was so much simpler without crazy friends.

We were neck-and-neck about half way across the yard when the computer spotted us. Two bright floodlights came on, illuminating the area where we lay. Ken, exercising reflex actions learned from prior military experience, dove into a prone position, as though he anticipated an imminent artillery barrage. At the same time the lights came on, the tumultuous roar of many vicious snarling dogs filled the yard.

Frozen in his position, Ken yelled, "What have you got, a pack of hungry timber wolves in the basement? What do you need an alarm for?"

"Don't talk. Just bark!"

"Bark?" Ken looked at me and shook his head.

"Bark," I said. "Like this. Arf! Arf! Arf!"

Soon we were both barking and woofing up a storm. Brenda and Whiskey would be proud of us. We kept it up for about forty-five seconds until the lights and the ferocious dogs stopped as miraculously as they had started.

Speaking very softly and not waiting for questions, I said, "Hey, you can stop barking. There's a laser perimeter intrusion detector in this corner of the yard. It sensed our presence below the three foot level. It turned on the floodlights and the recorded sounds of barking dogs.

"Now, here's what the computer is great for. After all that was triggered, the computer turned on a microphone to listen out here at the same time. When it heard us barking the same as any real dog would do upon hearing the recording, it shut off the alarm sequence. You see, Ken, the computer thinks we are just a dog that wandered through the yard and not an intruder. A real burglar, smart enough to see the different sensors and try to crawl as we have been doing, wouldn't know enough to bark back at the computer. Neat, huh? Now we can finish crawling to the house. It won't bother us again."

Ken rolled his eyes and put his muddy palm to his sweat laden forehead. As straight faced as one could be, considering the circumstances, he said, "Steve, you're crazy."

Not wishing to argue, since time was running out, I merely responded, "Genius is never appreciated until it's too late."

"Steve, tell me why I'm going through all this. What do you have in your house that is so valuable that you installed a system designed to counter an invasion?"

"Well, if I really think about it, I guess if you include the computer since it is an integral part, the alarm system itself is worth the most."

Ken didn't know how to respond to that information. We computer freaks design things sometimes just for the challenge. Unfortunately, this particular challenge was getting out of hand and time was very short.

The remaining distance across the lawn was far less wasteful than the first. We encountered no land mines, bear traps, or quicksand. We finally found ourselves resting against the house just below the bathroom window. Reaching the next objective was not as bad as the preceding events. The window itself was open! I warned Ken not to make any noise once he was inside the house. Then I hoisted him up to the window. Grabbing the top of the window frame for support, he lifted himself off my shoulders and knelt on the window ledge. Next, trying to be as graceful as he could in such an awkward position, Ken swung his body around so that he now sat on the sill, with the trunk of his body hanging outside the window and his legs projecting inside. Once in that position it was easy to swing into the bathroom and land squarely on the floor.

In a gymnasium Ken would have executed it perfectly. A small bathroom was quite another story. One foot came down squarely on the carpeted floor as it should have. The other foot came down squarely into the open toilet as it shouldn't have. Remembering that I had warned of excessive noise, he cursed very quietly as he extracted his foot from the toilet.

As he leaned out the window to help pull me up, he said, "Hey, Steve, I hear some kind of buzzer in the house."

I quickly glanced at my watch and responded, "That's the oven timer. It's running a little faster than I thought. Now the souffle is overcooking. Help me up. We haven't got much time."

Ken leaned out the window and grabbed the shoulders of my sweatshirt as I jumped up to the window ledge. My entrance was far less graceful than his. I had no alternative but to go through the window head first. I'd swear that Ken directed my flight towards the toilet on purpose, but I have no proof. At the last instant I was able to extend an arm to contact the bowl and apply a force opposite to that of my trajectory. The result was a dull, rolling thud on the bathroom floor.

Our totally dishevelled appearances lent no levity to the situation. But, we were inside the house and the stove was just twenty feet away. If we could get to the souffle in time to stop it from burning, we would have all the time in the world to shut off the rest of the alarm system.

"Ken, don't say anything louder than a whisper. There are mikes planted around the house and the computer is listening for loud noises, like breaking glass or us talking." I extended a forefinger against my lips to dramatize what I had said.

"Steve, I just saw something outside. Outside near the back yard!" Ken was looking out the

This Weekend:

**STIK
IT....
..to your**

TRS-80

That's right! Esmark's VIDIET-STIK light pen has the TRS-80 CONNECTION for LEVEL I & II. Your 4K to 48K TRS-80 System will come alive under your VIDIET-STIK within minutes of its arrival. That's because there are no wires to solder or traces to cut. You're up and running as fast as you can plug the interface into your system's cassette EAR-jack. CLOAD our custom LIGHT-WAVE demonstration software and RUN. And because the interface has a plug for your recorder, you won't have to unplug it again when loading your other software tapes. The interface allows them to pass right thru whenever you're not using the pen. It's exclusive "switched tip" design means the pen's electrically isolated from your system when it's not in use. Just point & press! It's that simple... Plug, CLOAD and RUN. And have we got the software for you to RUN with! Our demonstration tape includes a calibration program (used to adjust the CRT's brightness and contrast) plus STIK-TAC-TOE, AWARI and TOWERS. Two challenging games and a puzzle that will keep grown-ups and children Stik'ing it to your TRS-80 for hours. And there are instructions provided so you can begin writing your own light pen programs (lightware) for fun or profit (Level II). Or, just sit back and enjoy our LIGHT-WAVE tapes each month. Esmark's unmatched commitment to lightware can bring you up to five new games, puzzles, drills & educational quizzes or simulations each month. Our current LIGHT-WAVE releases are

- LIGHT PAK 2 LIGHTPEG (4 peg-jump puzzle)
(LEVEL II) ENDRUN (Othello with a twist)
LIFE9 (Conway's LIFE with mutations)
Price: \$19.95 (including postage & handling)
- LIGHT PAK 3 LITEGAMMON (Backgammon you'll Stik with)
(LEVEL III) STIKWUMPUS (Caves with a little "life")
MAZEMASTER (Maze alter maze to poke thru)
Price: \$19.95 (including postage & handling)

Order yours now and we'll include a free copy of FLASHBACK. Esmark's newsletter dedicated to the latest news in lightware applications. And don't forget to tell your friends. The VIDIET-STIK can also be ordered for use on most other micro systems using the following processor chips.

8080 Z80 6800 6502

All that's required is a standard cassette jack leading to Ground and a readable single bit input port. Driver software is provided along with instructions for writing lightware applications. And tell your local Dealer that Esmark's got a Dealer package he won't want to miss out on. Delivery is 3 to 6 weeks from receipt of your order. C.O.D.'s are \$3.00 extra but will be shipped within 2 weeks. All prices are F.O.B. Mishawaka, Indiana. Indiana residents add 4% sales tax.

ALSO COMING FROM ESMARK:

- TRS-80 Printer Interface (Cassette AUX-jack interface for all RS232 prints. Includes LLIST & LPRINT software)
 - TRS-80 RS232 Communications Interface (Makes your TRS-80 a full I/O terminal to time-sharing systems the world over. Gives you intelligent or dumb terminal capabilities at 110 or 300 BAUD. Also includes Printer Interface above with 20 mA current loop & TTL level I/O options.)
- TRS-80 is a trademark of Tandy Corporation —



ESMARK INCORPORATED
507 1/2 E. MCKINLEY HWY. MISHAWAKA, IN 46544
(219) 255-3035

\$62.95
PLUS \$1.50
POSTAGE &
HANDLING

VIDIET • STIK™
ESMARK INC. MISHAWAKA, IN 46544

READER SERVICE 12

THE S-EIGHTY

**INDEX TO
ADVERTISERS**

READER SERVICE

1	Lobo Drives	3
2	Sensational Software	24,25
3	80-US	32
4	Sun Technology	7
5	Cedat	2
6	Physician's Microcomputer Report	29
7	Electronic Specialists	29
8	Software Mart	20
9	Miller Microcomputing	20
10	Data Train	4
11	Business Micro Products	21
12	Esmark	16
14	The Software Exchange	17,22
15	Hardside	23,31
16	Micropute	20
17	Computer Information Exchange	7
18	Personal Computing	6
20	VR Data Corporation	21
21	Springfield Computer Show	17

**Keep Informed!
Get Information!**

With this issue we are using a pull-out reader response card for your convenience. Simply circle the reader service number that corresponds with the companies you are interested in (you'll find them at the bottom of the ads), fill in your name and address, place a stamp on the front and drop it in the mailbox — then sit back and let us do the rest! Our new reader service card will allow you to take advantage of all the latest product information, prices and discounts, as close as your mailbox, at the drop of a stamp.

MAIL YOURS TODAY!

From:

PLACE
STAMP
HERE



PUBLICATIONS
6 South Street,
Milford, NH 03055

**Ready to get serious? PROG/80 is the magazine
dedicated to serious programmers...beginners
to professionals.**

- documentation of features of the Radio Shack TRS-80
- complete listing of utility programs
- timesharing section and much more!

- \$15 Bulk**
 \$21 First Class USA—6 issues per year
 \$27 Overseas Airmail

Enclosed \$ _____ Check MO Bill: MC VISA

Card # _____ Expires _____ Interbank # _____

Name _____

Address _____

City _____ State _____ Zip _____

Signature _____

Please remit in US funds only

READER SERVICE

Valid until 9/30/80 (RS 7/80)

Please help us to bring you a better magazine by answering these questions:

1. Which description suits your system best?

- A. 16K TRS-80 Level II
- B. 32K TRS-80, Single Disk
- C. 48K TRS-80, Dual Disk or more
- D. TRS-80 Model II
- E. I do not own a TRS-80

2. How long have you owned your computer?

- A. less than 2 months
- B. 2-6 months
- C. 6 months to a year
- D. over 1 year

3. How much have you spent on software to date?

- A. Nothing
- B. less than \$50.00
- C. \$50.00 to \$200.00
- D. \$200.00 to \$1000.00
- E. over \$1000.00

4. Have you ever accepted copied/pirated commercial software?

- A. A couple of times when I first started computing
- B. Occasionally
- C. Routinely
- D. Never

5. Have you ever given out copied/pirated commercial software?

- A. Never
- B. Occasionally
- C. Routinely

6. Have you ever submitted a program to be published?

- A. No.
- B. Yes, was not accepted
- C. Yes, was accepted

Reader Service: To receive more information from any of the advertisers in this issue, circle the number on the Reader Service Card that corresponds with the Reader Service number on the ad in which you are interested.

1	6	11	16	21
2	7	12	17	22
3	8	13	18	23
4	9	14	19	24
5	10	15	20	25
26	31	36	41	46
27	32	37	42	47
28	33	38	43	48
29	34	39	44	49
30	35	40	45	50

Name _____

Address _____

City _____ State _____ Zip _____

From:

PLACE
STAMP
HERE

READER SERVICE

THE S-BIGHTY™

A SoftSide Publication
6 South Street,
Milford, NH 03055

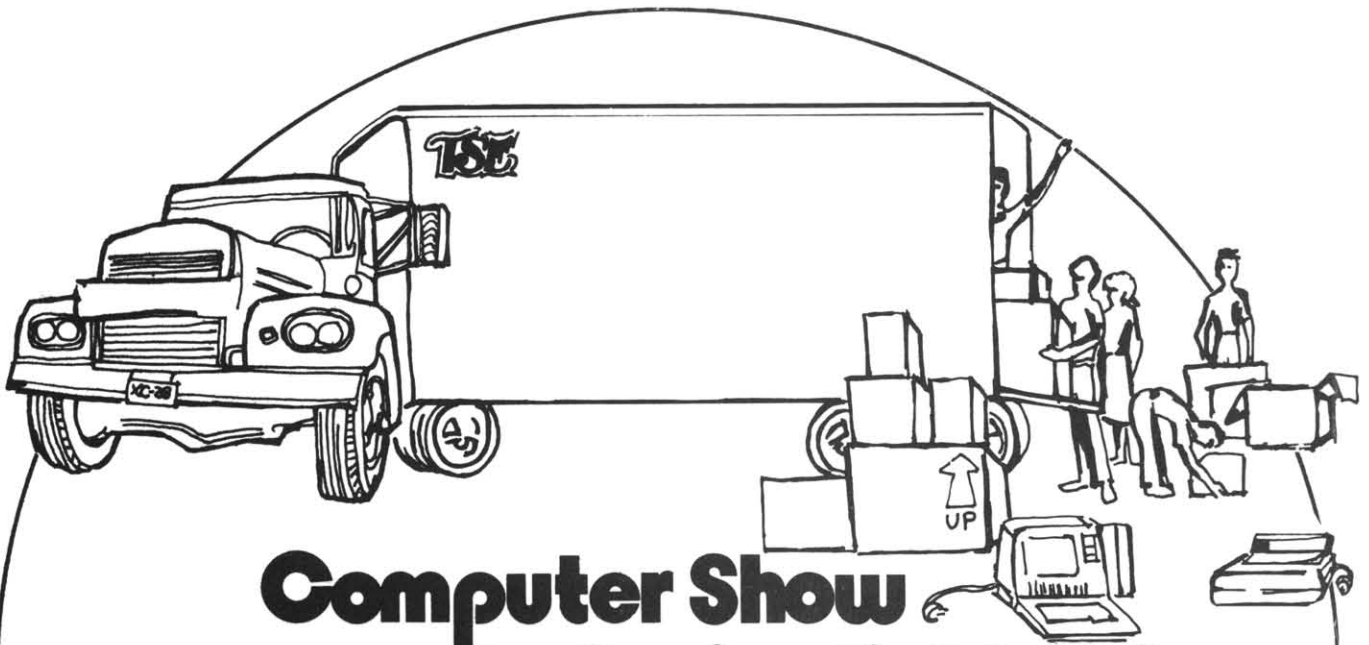

Computer Show comes to Springfield, MA

This great computer show, the first of it's kind in Springfield, is brought to you by The Software Exchange and HARDSIDE - leaders in software and hardware for the personal computing and small business market.

Enjoy demonstrations of the Atari, PET, TRS-80 and APPLE computers and find out how they can work for you.

Hundreds of the BEST programs will be operating in the same room.

- Adventure International
- Synergistic Software
- Peripherals Unlimited
- Racet Computes
- Small Business Systems Group
- Personal Software
- Level IV
- Acorn Software
- Hayden
- Muse
- Web Associates
- Apparat
- Microsoft
- Lance Micklus Inc.
- The Software Exchange
- Automated Simulations

Have you been looking for a particular book? We have it!

- LITTLE BOOK OF BASIC STYLE (Nevison)
- Z80 INSTRUCTION HANDBOOK (Scelbi)
- PATHWAYS THROUGH THE ROM (SoftSide)
- Z80 SOFTWARE GOURMET GUIDE AND COOKBOOK
- THE BASIC HANDBOOK (Lien)
- SARGON HANDBOOK (Spracklen)

Inspect the hardware you've been looking for:

- Percom Disk Drives
- Radio Shack Expansion Interfaces
- Busy Box
- Eaton LRC Printers
- NEC Spinwriters
- Voice Synthesizers
- Centronics Printers
- Modems
- Plus much more!!!

We'll be at the Rodeway Inn and Conference Center, Saturday, July 19, 10 AM to 7 PM and Sunday, July 20, 12 noon to 6 PM. The Rodeway Inn and Conference Center is conveniently located at the "Crossroads of New England" I-291 and the Massachusetts Turnpike -- Exit 6, Burnett Road, Chicopee, Massachusetts.

If you have any questions about the show, please call toll-free 1-800-258-1790 (in New Hampshire 603-673-5144)

July 19 & 20

The Software Exchange 6 SOUTH ST., MILFORD, NH 03055

To order: Call Toll-Free 1-800-258-1790 (in NH call (603) 673-5144)

The Software Exchange & HardSide (Div. of Robitaille & Sons, Enterprises, Inc.), SoftSide Publications



window and after a few moments excitedly pointed over my shoulder towards a dining room window, visible from the bathroom even though it was on the other side of the house. "There it is again!"

I jerked around in time to detect motion from an unknown object. "What do you think it is, Ken?"

Before he had time to answer, a human form stood for a second in front of the window. Extending from an arm was a long slender object. For a moment Ken and I just stood with our mouths open watching the proceedings. The figure turned suddenly. The slender object exhibited a metallic gleam in the moonlight. Then, the figure was gone, as quickly as it had appeared.

We looked at each other. Our eyes were wide open as we whispered in unison, "I think that was a gun!"

"I think we have a real prowler, Steve. What are we going to do? He has a gun, too!"

"Don't ask me! Remember, I'm stuck in this bathroom, too."

"Suppose. Now, just suppose he was able to get by all the alarms and got into the house. And, now just further suppose he fills his pillowcase and is about to leave when he decides to go to the bathroom. Voila, us two looking down the barrel of that gun!"

"Shhh, Ken. Don't be an alarmist. Nobody can get through my alarm system."

Simultaneously, as Ken spoke them, I thought of the exact same words, "But we did!"

The situation presented a problem. Should I leave the oven on and purposely trigger the alarm to bring help and catch the prowler? Or, should we still try to finish what we had started and then hope the perpetrator wasn't smart enough to make it through my alarm?

I looked at my watch. The souffle had to have been overcooking about ten minutes. The stove timer was buzzing relentlessly in the background. I sniffed the air. What had previously smelled freshly baked now definitely had the scent of being overdone. It would still take a few minutes before smoke would be produced that the computer could smell. We were in a real dilemma. We were caught between our protector and the prowler.

"Steve, look again!" Ken pointed towards the dining room window. "It's a woman!"

The figure was in full moonlight in front of the window. The features were easily discernable and I recognized the person immediately. The metallic glint previously thought to be a gun was the stainless steel tip of a walking cane. I grabbed Ken's arm tightly and said, "That's no woman. That's Mrs. Picker from across the street."

"Is that bad?" Ken had little experience with Mrs. Picker. He could not fully comprehend the grave position that we were now in.

"That's worse than any prowler with ten guns. She probably saw us and thinks we are the prowlers."

"Boy, that must really take guts to confront two prowlers single-handedly." Ken still didn't understand what I was trying to tell him.

"That feisty old lady may be eighty, but I wouldn't put it past her to climb over the fence after us if she discovered the rope. What I'm really worried about is that while she's looking for us, she'll probably set the alarm off. When the law arrives, guess who is wearing the cat burglar costumes and covered with

mud?"

Ken looked down at his clothes and back up at me. His eyes pleaded with me to act fast. We were in the worst possible combination of circumstances to be caught in. The only solution was to try to turn off the system before Mrs. Picker triggered it.

"Let's go," I said. "We still have to turn the oven off."

Ken agreed. We had no other choice. Extra time to shut off the system was gone. First we had to get to the stove. Motioning to Ken that he should follow in my exact footsteps and mimic my every motion, like a childhood game, we started the ordeal.

"Ken, see those two holes on either side of the door molding? Those are photosensors. The computer can tell if we pass through the door and in what direction we are going. Fortunately, they are only eighteen inches off the floor."

At the doorway of the bathroom I lifted my right leg very high and extended it out over the other side. Shifting my weight to the now firmly planted foot outside the bathroom, I retracted the other leg by reversing the process. Ken followed suit. We stood in the back hallway outside the bathroom.

"Every doorway we go through, we will have to follow the same procedure. Got it?" Ken nodded affirmatively as I continued to whisper, "Now, step over this area and these other two. There are pressure switches under the rug which will go off if you step on them. Try not to make too much noise jumping. Remember the mikes!"

The feeling we had was like being in combat. We were in the middle of a minefield directing those behind to follow in our footprints. While the sensation of stepping on a mine could not be exactly equalled by my computer, the heart attack following the first sound of that air raid siren could be just as lethal. We silently high-stepped and hopscotched our way through the house until we reached the stove.

As I extended an arm to turn the oven off, I could see the blackened souffle through the oven door window. It was very disconcerting to see a creation of one's hand and mind shrivelled and destroyed. But the realization that we were still at the mercy of another such creation prompted a fast exit. We had not gotten to the stove too soon. Inside it was filled with smoke. While not so dense as to obscure total view, I dared not open the oven door. The smell was of burned baked goods but not dense enough for the computer to get excited about, yet.

Our final objective was the cellar where the computer was headquartered. It was quicker to go there than try to find and insert the digital card in the reset mechanism in the front hallway. The motion sensors in that area of the house were not as easily overcome as the simpler variety that we had thus far defeated. The cellar door was but five feet and one pressure switch from the stove. We made it to this objective as easily as we had the others. There was no sensor on the door. I opened it slowly so that the squeaking of hinges would not reach an appreciable volume level.

When we opened the door, Whiskey and Brenda looked up at us. "No time to play now, guys," I said.

I went bounding down the stairs with Ken in close pursuit. "When the alarm is activated, the dogs are kept in the cellar. So, there are just a few sensors down here. We're home free now!"

Ken and I stood in front of the computer system. This computer did not have the usual panel full of flashing lights. That was old hat. The new stuff all had cathode ray tube displays. The particular television attached to this system displayed an outline of the house and sensor placements. Peripheral sensors, not directly used to determine specific alarm conditions and still experimental, scanned the grounds like radar. A dot flashed on the screen next to the outline of the house. It slowly moved around the periphery of the outline.

"That's Mrs. Picker." I pointed out to Ken. "The computer knows she's out there but ignores it until she gets over the fence into the back yard. See, she's moving in that direction now. I'll need about three minutes to enter the disarm commands."

Ken looked around the cellar at all the equipment and storage. Spying a refrigerator, he started to walk towards it. "Hey, Steve, why can't you just pull the plug on the computer."

"That wouldn't do anything. In case of a power failure, the computer has battery back up and all kinds of redundancy."

I started to type in the first password. Ken, who finally felt relaxed again, stood at the refrigerator and said, "Boy, all this work has really made me thirsty. Do you have any beer in here?"

He opened the refrigerator door. The fact that the refrigerator contained refreshment became immediately irrelevant. Suddenly a small speaker next to the computer started to emit a loud, repetitive sound: beep...beep...beep...beep.

"Ken, you triggered the alarm! It's going to go off in ten seconds!"

My mind raced with the thoughts of things which were about to happen. Everyone but the National Guard would be here in ten minutes. Large jetliners approaching the nearby airport would be distracted by the brilliant flashing lights and start to circle the house instead. They would find Ken and me in a state of partial rigor mortis from the loud horns which would now go off inside the house. The

computer had sensed an intruder. Finally, and most important, there was Mrs. Picker. If she was standing next to one of those sirens when it started, it would be final curtains!

Ken's eyes bulged with terror. Internally, he screamed, how could this be happening? Vocally, he yelled, "I thought you said that there were very few sensors down here because of the dogs! Why did it go off?!"

Simple, yet true. We were dont for but he still had to know. "Dogs don't open refrigerator doors. That's why."

The ten seconds had almost elapsed. My final words were, "Hit the deck! Cover your ears!" That was exactly what we did. It was a hard tiled cement floor but we dove under one of my work benches and covered our heads with our arms. Almost immediately the beeping stopped. Then, silence...and more silence...and more silence. After about fifteen seconds I peeked out. At thirty seconds we got up and walked over to the computer.

"I don't understand," I said. "It should have gone off. At the end of the beeping it should have started the sirens and lights and everything. I don't understand."

I walked over to the console and started to display the program on the display. "There must be a program bug. Otherwise it would have gone off." I busily typed on the keyboard as I spoke. "Gee, that's a lousy demonstration of my talents. I'm a better programmer than that."

"Ken, wait a few minutes and let me see if I can fix it. Ken, don't think this was all a waste of your time. It really works. Give me a minute or two to fix it and I'll show you."

Ken didn't wait. He gave me a really fierce leer and took off up the staircase. I yelled, "Where are you going? Don't you want to see this work?"

Ken yelled down the stairs. "I'll be right back. I'm just going to borrow Mrs. Picker's cane!"

NOTICE TO OUR ADVERTISERS

Change in Advertising Deadlines

Effective with the September Issue of the S-8IGHTY, advertising deadlines are as follows:

SPACE RESERVATIONS:

15th of month, two months preceding cover date (i.e., July 15 for September issue)

COPY DEADLINE:

20th of month, 2 months preceding cover date.

NEW OFFERS!

MICROPUTE SOFTWARE

ORGAN: Play your TRS-80 like a real electronic organ. Video display shows a two manual organ keyboard with corresponding TRS-80 characters overlaid. Change the quality of sound, two loudness settings, play single notes or chords. Output sound to cassette or directly through a small amplifier (through the auxiliary jack). Instructions and cassette only \$14.95

NANNY: A complete household finance package. Let "NANNY" help you with your household budget, balance your checkbook, monitor savings and investment growth. Keep up with your credit payments, interest, and tax deductions. Output to either video or line printer. SPECIFY DISK or CASSETTE version. For Level II, 16K and up. Instruction manual and program cassette — Only \$39.95.

SPECIAL INTRODUCTORY OFFER: If you buy ASPTCH now, you will receive two new programs free. Get SYSTPE which permits you to copy any number of distinct memory areas into one System format tape and BREAK, a program which allows you to stop execution of a program being debugged and display flag and register conditions.

TERMS: We accept check, money order, Master Charge/Visa Card. North Carolina residents add 4% sales tax.

Send orders to: Micropute Software, P.O. Box 1943, Rocky Mount, North Carolina 27801

CASSETTE BASED MACHINE LANGUAGE PROGRAMMERS, REJOICE!

Are you tired of reloading Radio Shack's Editor/Assembler and the source and object tapes every time you want to try out a program that you are debugging? If so,

YOU CANNOT AFFORD TO BE WITHOUT

"ASPTCH 2.0"

by James F. Williams

ASPTCH loads after EDTASM and adds these functions:

1. Reserve area at top of memory
2. Display number of bytes left in text buffer
3. Dump assembled program DIRECTLY into that area without using a cassette
4. Execute the dumped program
5. Convert and display memory locations and their contents
6. Enter Level II BASIC's Monitor mode (system prompt)
7. Enter Level II BASIC's command mode and use all functions that do not use variables
8. Return to fully programmable BASIC, keeping dumped programs intact, if desired (for use with BASIC's USR command, for example).

You may return to EDTASM after using any of the above features. The text buffer stays intact for options 1-7.

ASPTCH also has its own unique keybounce routine that may be reinitialized after entering fully programmable BASIC (it speeds up BASIC execution).

ASPTCH actually increases the size of the text buffer available if no memory is reserved. The increased text buffer will be reduced only by the amount reserved for machine language programs.

ASPTCH requires TRS-80 Level II, 16K and up and is used with Radio Shack's Editor/Assembler 1.2

Send \$19.95 (N.C. residents add 4% sales tax) to Micropute Software, P.O. Box 1943, Rocky Mount, North Carolina, 27801, for your program cassette and instructor's manual.

TRS-80 Owners!

Software that means Business

Available for immediate delivery

- Order Entry
- Invoicing
- Inventory Control
- Accounts Payable
- Accounts Receivable
- Payroll
- General Ledger
- Medical/Dental
- Sales/Marketing
- Stock Market
- Data Base System
- Word Processing
- Business Statistics
- Games
- Custom Business Programs

All Business Programs Operate With Printer. Call or send for our complete catalog today.

Software Mart

24092 Pandora Street
El Toro, California 92630
(714) 768-7818

READER SERVICE 8

FORTH is an advanced language and system for advanced programmers. MMSFORTH is a professional version tailored to the Radio Shack TRS-80 Model I and supported by Miller Microcomputer Services.

- Structured & Modular Programming, Expandable Instruction Set with Source Code Graphics, Strings, Arrays, Double-Precision, Very Fast and Compact, Virtual Memory 5 Demo Programs with Source Code
 - Interpreter, Compiler, Assembler, Full-Screen Editor, \$64.95
 - MMSFORTH System Cassette (16K, 1 drive) \$44.95
 - MMSFORTH PRIMER (required for above) \$15.00
 - THE DATAHANDLER in MMSFORTH (32K, 1 drive) — an exceptionally fast, flexible and easy to use Data Base Management System \$49.95
 - P I M S MANUAL (required for DATAHANDLER) \$ 9.95
 - FLOATING POINT MATH and FULL Z80 ASSEMBLER \$29.95
 - Diskette (16K, 1 drive) \$25.00
 - Other FORTH literature: \$19.95
 - USING FORTH — beyond microFORTH PRIMER \$ 6.95
 - URTH TUTORIAL MANUAL — very readable introduction
 - CALTECH FORTH MANUAL — good on FORTH internal structure
- Shipping is \$2 plus \$1 per extra book. Mass. orders add 5% tax.

mmsFORTH

MILLER MICROCOMPUTER SERVICES
61 Lake Shore Road, Natick MA 01760 (617)-653-6136
Send SASE for free information

READER SERVICE 9

**BEST SELLING INFORMATION
MANAGEMENT SYSTEM IN
MICROS TODAY!!**

SELECTOR III-C2

- Powerful
- Creates and Maintains Multi-key data bases.
- Prints **FORMATED, SORTED REPORTS** with numerical summaries.
- Source code supplied
- Prints **MAILING LABELS** — and more!
- Comes with **APPLICATIONS PROGRAMS** including:

- Sales Activity
- Inventory
- Payables
- Receivables
- NAD
- Expense Register
- Checks Register
- Client/Patient Record
- Appointments
- Library

File management and report writing modules contain linkage to user subroutines to add virtually any special purpose application.

STATE OF THE ART in information management systems!

NEW — "Ready-to-run" version for the TRS-80® Model I, only from Business Microproducts. Also available for Model II.

Requires CP/M operating system or derivative and CBASIC2.

Offered on 5 1/4" or 8" all versions... **\$295.***
CBASIC2 with Selector Purchase... **\$75.***

TRSDOS → CP/M

FILE TRAN

"BRIDGES THE GAP"

- Machine language **COM FILE** directly compatible with your CP/M system
- Automated Terminal Configurator
- Memory displayed in both **HEX** and **ASCII**
- Any disk Sector-Selected and displayed in both **HEX** and **ASCII**
- Transfers both data and program files by file name byte by byte
- Newly created files scanned for potential errors between level II **BASIC & MBASIC 5.0** or later
- CP/M files scanned for any selected string
- Searches any program for all occurrences of any string
- Generates a variable cross reference invaluable feature for any system level conversion and debugging
- Displays both **CP/M & TRSDOS** directories
- And more

FILETRAN Disk and Manual **\$99**
Manual alone (manual price credited to system) **\$20**

ORDER NOW



A DIVISION OF THE READY CORPORATION
LIVERMORE FINANCIAL CENTER
1838 Catalina Court • Livermore, CA 94550
(415) 449-4412

VISA _____ M/C _____

*** NEW *** **NEVADA COBOL**

- ✓ A **POWERFUL** subset of ANSI-74
- ✓ A **PRICE** that's **UNBEATABLE**—\$99.
- ✓ **EXTENDED** arithmetic & I/O features.
- ✓ **FAST** compilation and execution
- ✓ **EASY** to use — Generates small executable object modules.
- ✓ **UNIQUE** — Easily understood error messages
- ✓ **CP/M** compatible
- ✓ Also available **ON TRS-80**
- ✓ **REQUIRES** only **16K-RAM**
- ✓ Designed for **PORTABILITY**

STANDARD FEATURES

- Random access file structure
- Sequential files — Fixed and variable length
- Debugging capability
- Copy statement
- Data types & character string. 16 Bit Binary and packed decimal (Comp-3)
- 18-Digit accuracy
- Hexadecimal non-numeric literals
- Powerful editing
- Interactive accept/display

Offered on both 5 1/4" and 8" diskette, all versions... **\$99***

*CA residents add 6% sales tax. Inter-continental shipping \$3.00 Allow 2 weeks delivery.

READER SERVICE 11

TRS-80 is a trademark of the Tandy Corp
CP/M is a trademark of Digital Research

**TRS-80™
MODEL II 64K 3626⁰⁰**

IN STOCK • FULLY GUARANTEED

ORDER NOW (1) 800-345-8102

MODEL II DISK DRIVES

- SINGLE DRIVE, SINGLE ENCLOSURE **\$ 899.00**
- SINGLE DRIVE, MULTIPLE ENCLOSURE **\$1050.00**
- ADDITIONAL DRIVES FOR MULT. ENCL. **\$ 540.00**

IMMEDIATE DELIVERY

DISK DRIVES 350⁰⁰

- OVER \$149.00 LESS THAN RADIO SHACK
- TRS-80 MODEL I COMP. DRIVES

INTERTEC SUPERBRAIN

32K **\$2995.00** • 64K **\$3170.00**

ORDER NOW (1) 800-345-8102

EXPANSION INTERFACES • IMMEDIATE DELIVERY

0 K **\$ 278.10** • 16 K **\$ 376.10** • 32 K **\$ 474.10**

	LIST PRICE	OUR PRICE		OUR PRICE
TRS-80 4K LEVEL II	\$619.00	\$ 575.70	NEC 5510 (IN STOCK)	\$2995.00
TRS-80 16K LEVEL II	\$849.00	\$ 789.60	CENTRONICS 730	\$ 695.00
TELEPHONE MODEM	\$199.00	\$ 185.10	CENTRONICS 737	\$ 950.00
KEY PADS	\$79.00	\$ 73.40	C-10H LETTER QUALITY	\$2195.00
RS-232	\$99.00	\$ 92.10	PRINTER	

VR DATA
1-800-345-8102
(215) 461-5300

777 HENDERSON BLVD.
FOLCROFT INDUSTRIAL PARK
FOLCROFT, PA 19032
AD'S PRICES ARE CASH DISCOUNTED

**V R DATA'S TRS-80™
SWEEPSTAKES**

Celebrating V. R. DATA's 8th Anniversary

OVER \$1700.00 in PRIZES

GRAND PRIZE - 16K LII TRS-80

TWO SECOND PRIZES - DISK DRIVES

FOUR THIRD PRIZES - \$50.00 Gift Certificates

SWEEPSTAKES RULES

1. ALL ENTRIES MUST BE SUBMITTED ON ORIGINAL ENTRY BLANK.
2. ONE ENTRY PER PERSON.
3. WINNERS SELECTED BY RANDOM DRAWING, NOTIFIED BY MAIL.
4. ENTRIES MUST BE RECEIVED BY 10/31/80.
5. VOID WHERE PROHIBITED BY LAW, NO PURCHASE NECESSARY.

MAIL NOW TO ENTER V. R. DATA'S SWEEPSTAKES

NAME _____
ADDRESS _____
CITY _____ STATE _____ ZIP _____
TELEPHONE _____ OCCUPATION _____
COMPUTER EQUIPMENT OWNED _____

INTENDED USE _____

S-80 **SEND FOR CATALOG**



Buy the best software and get the fastest service - from us.

TRS-80*

APL 80

by Phelps Gates
The powerful scientific language is now available for the TRS-80. Disk version includes lessons, self-teaching manual, and the book, "APL: An Interactive Approach". Tape version loads in 16K Level II. Disk version permits up to 4 workspaces, user-defined functions, return to DOS without losing workspaces, and many other features.
16K Level II cassette \$14.95
32K disk with book \$54.95
book separately \$15.50 + \$1

UP PERISCOPE

by Ron Potkin
Two players are pitted against one another as one tries to defend a convoy crossing the 32 x 32 hex area of sea. Submarine commander player tries to sink as many convoy ships as possible. If sub player sinks 3 or more of the 6 convoy ships, he wins. Standard hex-grid playing surface, torpedoes, ramming power, and depth charge capabilities bring back the thrill of open sea battles.
16K Level II cassette \$14.95

INVASION

by Chris Freund
Your favorite arcade is now available for the TRS-80. Try to hit the descending aliens before they land on the bottom of the screen. Written in machine language for quick response, and no need to [ENTER]. Constantly moving graphics and synchronized sound effects make this a must for the arcade fanatic. Saves on quarters too!
16K Level II cassette \$9.95
32K disk \$14.95

APPLE*

MICROSOFT ADVENTURE

The original of ADVENTURE written for the DEC-10 systems is now available for the APPLE. Explore Colossal Cave for treasures while avoiding the dangers hidden within its many passages. 130 different rooms, 15 treasures, and characters ranging from helpful to deadly await you within the cave. Be careful where you step, and also who's behind you!
32K disk machine language \$29.95

ANDROID NIM

by Leo Christopherson
The game that made Leo Christopherson famous is now available for the APPLE! The improved graphics and color of the APPLE make the game even better. Try to be the last one to shoot the androids on the screen, if you do you win! Also includes realistic sound effects.
24K cassette machine language \$14.95

MAGIC PAINT BRUSH

Hi-Res graphics package plus! Draw Hi-Res pictures using all APPLE's colors. Connect any points on screen, fill areas, plot, rotate, and scale shapes, or paint with a set of 9 brushes. Also comes with Shape Table Designer and 2 demo programs. Slot Machine and Applesoft Invaders.
32K disk Applesoft-ROM \$29.95

THREE-D

You don't have to be an engineer or scientist to have high resolution graphics for your computer! This program permits rotation, scaling shift, distortion, and combination of three dimensional graphics on the screen. MP Software.
48K disk Applesoft-ROM \$29.95

ATARI*

STAR RAIDERS

The best! A ROM cartridge holds the game, a fast-paced full-color, space battle in which you must defeat the enemy Zylon ships while protecting your home bases. Real-time action, and effects make this game the best space game available. Sixty levels of rating from Garbage Scow 4th Class to Commander make for continuously exciting play.
ROM cartridge \$59.95

3D GRAPHICS

by Tim Hays
High quality graphics program for the ATARI computer allows you to rotate, distort, shrink and combine three dimension graphic projections on the screen. With the high resolution abilities of the ATARI one of the finest graphics packages available anywhere!
16K cassette \$29.95

WALL STREET CHALLENGE 6402

A computer simulation of the Stock Exchange is easy to play and always challenging. Invest in stocks and try to make it big!
8K and 16K versions on one cassette \$19.95

ALL STAR BASEBALL 6401

Two players face each other, one at bat, and the other pitcher and outfield. Innings, balls, strikes, and a variety of plays make for an exciting game. Joysticks are optional. 8K and 16K versions on one cassette \$19.95

PET*

STARFLEET ORION

Command 3 starfleets! 2 player game system includes rule book, battle manual, control sheets, 2 programs, 22 space ship types and 12 play tested scenarios.
8K cassette \$19.95

RESCUE AT RIGEL

Search the moon base and rescue Delilah Rookh from the High Tollah. Automated Simulations.
24K cassette \$19.95

MORLOC'S TOWER

Match wits with the evil wizard and try to defeat him! Automated Simulations.
32K cassette \$14.95

TIME TREK

by Brad Templeton from Personal Software. Real time action Star Trek type game with sound effects. There are no 'turns', the action continues whether you move or not. You and the Klingons can move, steer, and fire at the same time.
8K cassette \$14.95

This is only a very small sample of our product line. For a complete selection, send \$1 for our catalog of hardware, software and publications and receive a \$2 credit toward your first order.

*TRS-80, APPLE, ATARI, and PET are trademarks of Tandy Corp., Apple Computer Co., Warner Communications, and Commodore, respectively

The Software Exchange

6 SOUTH ST., MILFORD, NH 03055

To order: Call Toll-Free 1-800-258-1790 (in NH call (603) 673-5144)

The Software Exchange & HardSide (Div. of Robitaille & Sons, Enterprises, Inc.), SoftSide Publications



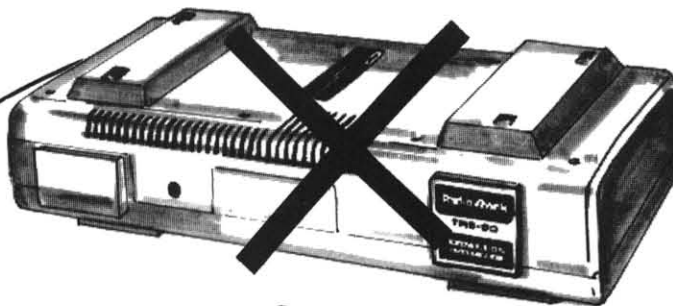

TRS-80* interfacing alternatives...

Featuring the Quality Engineering and Manufacturing of Steve Ciarcia and Micromint



COMM-80

- FULL 8-BIT PARALLEL PORT
- RS-232-C PORT (up to 19,200 baud)
- UP TO 16 UNITS CAN BE CHAINED TOGETHER
- TRS-BUS CONNECTOR FOR FUTURE EXPANSION
- CONNECTS TO KEYBOARD OR E.I.
- ONLY \$179.95

CHATTER BOX

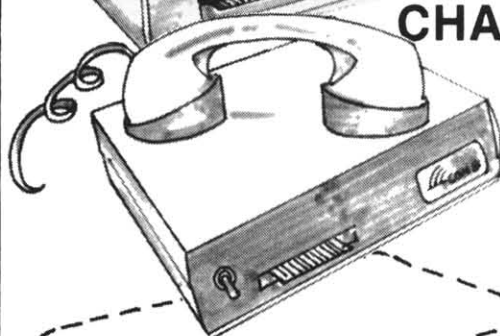

- FULL 8-BIT PARALLEL PORT
- RS-232-C PORT (up to 19,200 baud)
- ACOUSTIC MODEM
- TRS-BUS CONNECTOR FOR FUTURE EXPANSION
- CONNECTS TO KEYBOARD OR E.I.
- INCLUDES TERMINAL SOFTWARE
- ONLY \$259.95

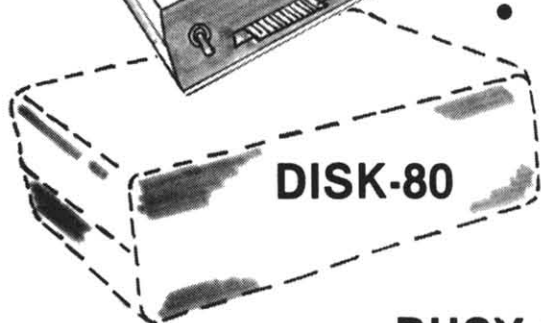

DISK-80

- DISK CONTROLLER (up to 4 drives)
- DATA SEPARATOR
- INCLUDES 16K OF RAM
- PROVISION FOR AN ADDITIONAL 16K RAM
- TRS-BUS CONNECTOR FOR FUTURE EXPANSION
- Available September 1980
- ONLY \$299.95

BUSY BOX

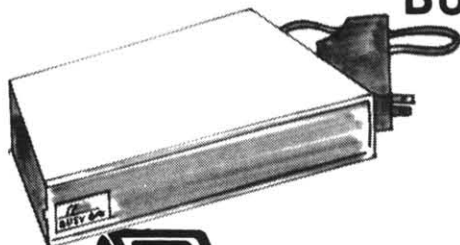

- 8 1/4" x 6 2/5" PLASTIC CASE
- CABLE AND CONNECTOR FOR TRS-80 KEYBOARD E.I.
- OPERATING MANUAL
- INCLUDES BASIC LISTING FOR CONTROL ROUTINE
- LEVEL II MINIMUM SYSTEM
- ONLY \$109.95

*TRS-80 is a trademark of Tandy Corp.



6 SOUTH ST., MILFORD, NH 03055

To order: Call Toll-Free 1-800-258-1790 (in NH call (603) 673-5144)

The Software Exchange & HardSide (Div. of Robitaille & Sons, Enterprises, Inc.), SoftSide Publications





Board Games-1, CS-3001 (16K)

• Mugwump \$7.95

Mugwump is a board game which uses a 10x10 grid on which four friendly Mugwumps are hiding. Your mission is to locate these mysterious animals and capture them.

• Flip Disc

Are you an Othello freak? Flip Disc is a program which will turn your computer into an excellent opponent. Three different skill levels, (good, expert, and genius), provide an introduction for the novice and continuing interest for the experienced player.

• Wumpus

In game 1, you scour a network of underground caves in search of the prized Wumpus. Bagging a Wumpus wins the game, but if you accidentally stumble into his cave, the Wumpus will enjoy a tasty dinner of sauteed computer freak.

• Wumpus 2

If you master the dodecahedron cave network in Wumpus 1, you may proceed to Wumpus 2 which allows you to choose from five different caves, or you can design your own.

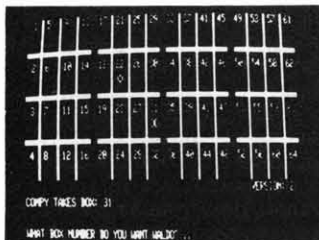

• Qubic

Qubic is a three dimensional Tic Tac Toe game. The game is played in a 3 dimensional cube (4x4x4). The object is to outwit the computer and place four pieces in any straight line.

• Backgammon

This is the TRS-80 adaptation of the popular board game. Backgammon uses graphics and all the standard backgammon rules, not a strange computer variation. The computer is your opponent in this version, written by Scott Adams of "Adventure" fame.

WRITE FOR...
FREE
SOFTWARE CATALOG

Space Games-3, CS-3002 (16K)

• Ultra-Trek \$7.95

Ultra-Trek is a fast-paced version of Star Trek, complete with "real time" action graphics, lasers, Nilon space mines, high energy photon torpedoes, enemy ships that move, and an experimental ray which does something different each time you use it. You must act quickly to save yourself and the Federation.

• Star Lanes

Imagine yourself the president of an intergalactic shipping company. If you're successful, you may be named Imperial Advisor on Economic Affairs. Entrepreneurs: to your ships.

• Star Wars

If you hate Darth Vader, you'll love Star Wars. This real time game is fun for aliens of all ages. May the Force be with you!

• Romulan

Your mission is to destroy an invading Romulan space craft. Maneuver through space and around stars looking for the deadly enemy, but be careful! The nasty Romulans fire back.

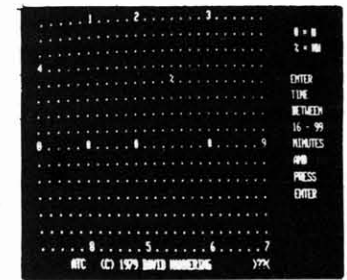

Air Traffic Controller, CS-3006 (16K) \$7.95

This real time machine language program puts you in the chair of an air traffic controller. There are 27 airplanes — jets and prop planes — which must be controlled as they land, take off and fly over your air space. You give the orders to change altitude, turn, maintain a holding pattern, clear for approach, and land at your two airports. This realistic simulation includes navigational beacons, and requires planes to take off and land into the wind. Air Traffic Controller was written by an air traffic controller and is a favorite of the Creative Computing staff!

For the SERIOUS Game Player

...
**sensational
software**

Who Is Creative Computing?

Creative Computing consists of five divisions serving you. **Creative Computing magazine** is the number 1 magazine of software and applications. **Creative Computing Press** publishes a wide variety of books, art prints, posters and T-shirts for the computer enthusiast. And **Creative Computing Software** produces and markets software on cassette and floppy disk for a wide variety of computers for home, school, and small business.

If your dealer does not carry the full line of Creative Computing products, please send three first-class stamps for a free catalog of products.

Adventure

Welcome to an astonishing new experience! **ADVENTURE** is one of the most challenging and innovative games available for your TRS-80.

• Adventureland

You wander through an enchanted world trying to recover the 13 lost treasures and encounter WILD ANIMALS, MAGICAL BEINGS, and many other perils and puzzles.

CS-3008 TRS-80 16K Level II \$14.95
CS-3506 TRS-80 48K DISK \$24.95

(Includes Pirate Adventure)

• Pirate Adventure

Can you recover LONG JOHN SILVER's lost treasure.

CS-3007 TRS-80 16K Level II \$14.95
CS-3506 TRS-80 32K DISK \$24.95

(Includes Adventureland)

• Mission Impossible Adventure

Will you be able to complete your mission in time? Or is the world's first automated nuclear reactor doomed?

CS-3009 TRS-80 16K Level II \$14.95
CS-3507 TRS-80 32K DISK \$24.95

(Includes Voodoo Adventure)

• Voodoo Castle

Count Cristo has had a fiendish curse put on him by his enemies. Will you be able to rescue him or is he forever doomed?

CS-3010 TRS-80 Level II \$14.95
(Available in November)

CS-3507 TRS-80 32K DISK \$24.95
(Includes Mission Impossible)

• The Count

You'll love this Adventure; in fact, you might say it's LOVE AT FIRST BITE...

CS-3011 TRS-80 Level II \$14.95
(Available in November)

Strategy Games, CS-3005 (16K)

• Tunnel Vision \$7.95

You are transported into a massive labyrinth and must find the exit or be lost forever. This is an excellent example of three dimensional perspective using TRS-80 graphics.

• Evasion

In this real time game, you are pursued around the game board by an evil-looking snake. Variations of play include two different speeds and hyper-jumps which randomly relocate you on the board. Looking for an escape? Try Evasion.

• Jigsaw

Jigsaw is a computer-age puzzle game making extensive use of TRS-80 graphics. The computer generates a random puzzle and puzzle board. Using a combination of deductive reasoning and luck you must fit the graphically represented puzzle piece into place.

• The Masters

Are you a wandering pro or just a Sunday golfer who would like to keep in practice? Once you're on the green, a worm's-eye view is displayed for putting.

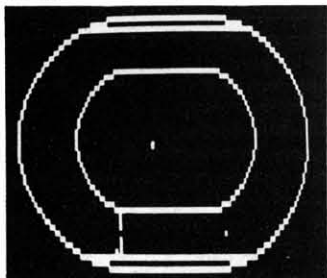

• Motor Racing

Motor Racing combines real time racing action with advanced graphics functions. The graphics and animation make Motor Racing fun to watch as well as play.

Pursuit Games, CS-3004 (16K)

• Stock Car Race \$7.95

Stock Car Race is a real time racing game on a road race circuit.

• Maze

You are timed throughout your run and rated on the basis of elapsed time and the number of moves required to escape. Nine skill levels.

• Indy Racer

Indy Racer is a real time racing game for the TRS-80. Similar to the popular arcade-style driving games.

• Depth Charge

As commander of a destroyer, your mission is to destroy as many enemy subs as possible in this re-creation of the Battle of the Atlantic.

• Kaleidoscope

This graphics demonstration program turns your TRS-80 into a computer age kaleidoscope.



Creative Computing Magazine

Creative Computing has long been Number 1 in applications and software for micros, minis, and time-sharing systems for homes, schools and small businesses. Loads of applications every issue: text editing, graphics, communications, artificial intelligence, simulations, data base and file systems, music synthesis, analog control. Complete programs with sample runs. Programming techniques: sort algorithms, file structures, shuffling, etc. Coverage of electronic and video games and other related consumer electronics products, too.

Just getting started? Then turn to our technology tutorials, learning activities, short programs, and problem solving pages. No-nonsense book reviews, too. Even some fiction and foolishness.

Subscriptions: 1 year \$15, 3 years \$40. Foreign, add \$9/year surface postage, \$26/year air.

Basic Computer Games

Edited by David Ahl, this book contains 101 imaginative and challenging games for one, two, or more players — Basketball, Craps, Gomoko, Blackjack, Even Wins, Super Star Trek, Bombs Away, Horserace. Simulate lunar landings. Play the stock market. Write poetry. Draw pictures.

All programs are complete with listing in Microsoft Basic, sample run and description. Basic conversion table included. 125,000 copies in print. 192 pages softbound. [6C] \$7.50.



More Basic Computer Games

Contains 84 fascinating and entertaining games for solo and group play — evade a man-eating rabbit, crack a safe, tame a wild horse, become a millionaire, race your Ferrari, joust with a knight, trek across the desert on your camel, navigate in deep space.

All games come complete with program listing in Microsoft Basic, sample run and description. 192 pages softbound. [6C2] \$7.50.



The Best of Creative Computing

The first two years of **Creative Computing** magazine have been edited into two big blockbuster books. **American Vocational Journal** said of Volume 1, "This book is the 'Whole Earth Catalog' of computers." [6A] Volume 2 continues in the same tradition. "Non-technical in approach, its pages are filled with information, articles, games and activities. Fun layout." — **American Libraries**. [6B] Each volume \$8.95.

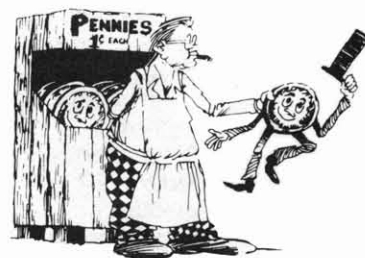

Computer Coin Games

Computer Coin Games by Joe Weisbecker aids newcomers to the field of computers by simplifying the concepts of computer circuitry through games which can be played with a few pennies and full sized playing boards in the book. Enhanced by outrageous cartoons, teachers, students and self-learners of all ages will enjoy this 96 page softbound book. [10R] \$3.95.

How To Order

Send order and payment to **Creative Computing**, P.O. Box 789-M, Morristown, NJ 07960. Add \$1.00 shipping and handling per order (foreign, \$2.50) N.J. residents add 5% sales tax. Visa, MasterCard and American Express orders welcome. For faster service, call in your bank card order toll free to: **800-631-8112**. (In NJ, call (201) 540-0445.)

Creative Computing



INTEGRATED CASSETTE CONTROL

Tape motor control; play, cload, and csave audio; high-low volume control; computer sound amplifier; and elimination of cloading volume sensitivity all built into the CTR-41 recorder itself.

by Lawrence E. Whittier

In the July 1979 issue of Prog 80 there is an article entitled "Cassette Controller" by John D. Eaton. It has several good ideas but I ended up modifying my TRS-80 system a little differently.

To use a switch is much more convenient than typing CSAVE and pushing the reset button, especially when all you want to do is run the tape just a short distance. Constantly pulling the plug in and out can be frustrating as well as a disaster to the plug itself. But why put this switch into a separate box? It is to be used to control the motor within the CTR-41 so why not put the switch there? Because the label says; "Do not open this cover, you are too dumb to fix me anyway." So I opened the cover and plopped a switch into it. What a relief!

The next problem is that of audio. To hear a tape you must yank out the EAR plug. If you have more than one program on a cassette, you have to start CLOADING between the two programs. You can't start on the last portion of one program and have it CLOAD the next program. Therefore, you need sound so you can tell just where the program is located on the tape. Again, why put the switch into a separate box and then have to also add a separate speaker just because the one inside the cassette player won't work without pulling the EAR plug? Put the switch into the tape player itself. This way it can also be wired to give sound during CSAVE and CLOADING as well as just finding a program on the tape!

Now I decided to add a third switch because I don't want to always have this sound at full blast. This switch controls the volume from loud to soft. Remember the regular volume control can't be fiddled with during CLOADING as this operation is normally very sensitive to the volume setting. And if it is moved at other times, we'll occasionally be forgetting to put it back.

I decided not to bother with the VU meter idea for now, as there was just no way of conveniently inserting one of those into the CTR-41. The reason John Eaton used this was to determine the correct volume setting for CLOADING the cassette programs. This would save a lot of time otherwise used trying to find the correct setting by hit or miss on individual tapes.

"A Sound Subroutine" by James Garon is located in the front of the same Prog 80. Whoopie, I wanted to be able to program those sounds! But now they want me to dangle a third speaker from my computer. What's more, you need a separate amplifier to operate it. Also, if you buy a ready-built unit it may require batteries. And to top it all off — the EAR plug has to be plucked out of the recorder and back into the new amplifier!!! (The CTR-41 has a larger speaker than the CTR-80.) All you need is one more switch placed into the CTR-41; theoretically, that is. I originally used a DPDT switch. One side of the switch is used to turn the amplifier on while at the same time taking the cassette motor out of the circuit so that this amplifier can be used forever without wearing out the recorder. The other side of the switch is used to rearrange the wiring on the S1-2 portion of the record switch S1. This is the input of the amplifier and these three wires are extremely sensitive to any magnetic induction. And if you look inside the CTR-41, you'll notice that the most convenient location for the four switches is right next to the power transformer, unless you want to disable the battery compartment. You've never heard such a loud hum in all your born days! Horrors! Even shielded cable was of absolutely no help. Panic! The switch would have to be moved. Oh no, I already drilled the holes. Then a brilliant idea came to mind and almost blew my synapses. A micro switch could be actuated by whatever internal lever is actuated by the PLAY, RECORD, FAST, FORWARD and REWIND levers. It would have to be wired just opposite from the way the switch would have been. That is, when the tape player is being used and the micro switch is actuated, it must not change the record switch wiring. It is to change it only when the tape player is not playing or recording. At this time it doesn't matter if the circuit is rearranged and it gives a perfect setup for the amplifier mode of operation. Now my toggle switch would only have to turn on the power and take the motor out of the circuit. There would be a perfect place to mount this micro switch except that right where I wanted to drill the three terminal holes in the circuit board there is a concentrated mass of solder connections. Foiled again. While touring Radio Shack later, somewhat miraculously, I spotted a 5VDC DIP RELAY - the perfect answer. Right behind the tone switch there is a very convenient location for it. It can be wired direct, but I put it in series with a 27 ohm resistor so that it wouldn't use any more

power than it needs, which is important if you ever want to use batteries. I also use a 16 pin low profile (thin) IC socket with eight of the pins pulled out. Some of the holes are already in the board. A

couple of short pieces of trace had to be cut and repaired with jumper wires because they were in the way. The three amplifier wires can now be kept very short and far away from the transformer.

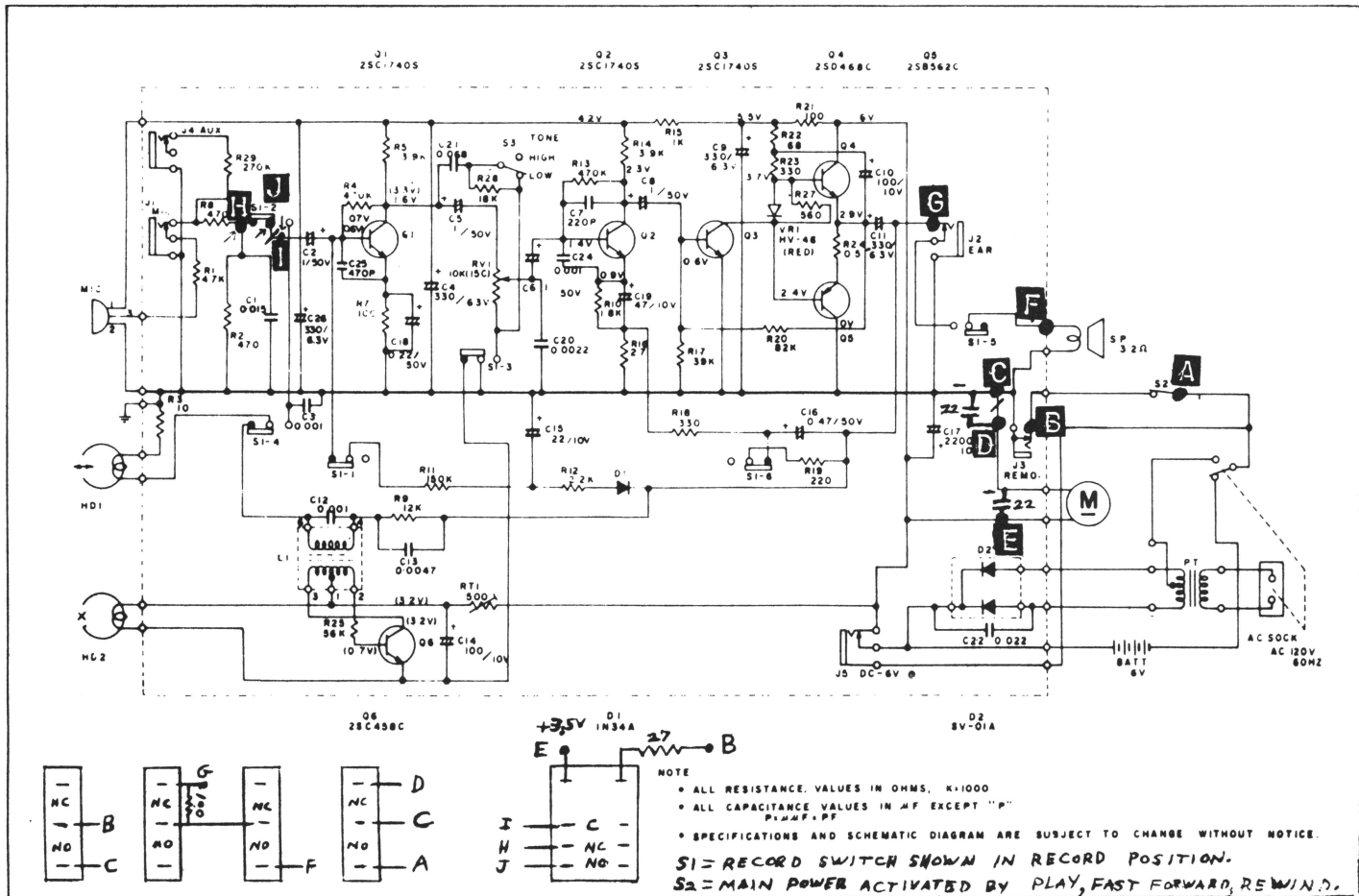

REM VOL SPK AMP

Success at last. Now all I had to do was to put the cover back onto the CTR-41. To do this one must first pull out the plugs. I started by pulling out the remote plug. Oh, my goodness! A horrendous hum came flying out of that speaker. Why me? What did I do wrong? Since the player was upside down, I didn't notice that the play lever hadn't been released. If it had been released, this problem would have gone unnoticed forever and

ever. I then pulled the next plug (AUX) and the hum disappeared. I put it back in and it came back. I pulled the EAR plug and it disappeared again. It hummed only when both the AUX and EAR were plugged in at the same time and the REM was unplugged. The unplugged REMOTE simply turns on the power. But the AUX and EAR circuit was causing a problem. A check with an ohm meter showed that these two cable grounds, or shields, are shorted together inside the TRS-80 keyboard. For some reason the CTR-41 didn't like this.

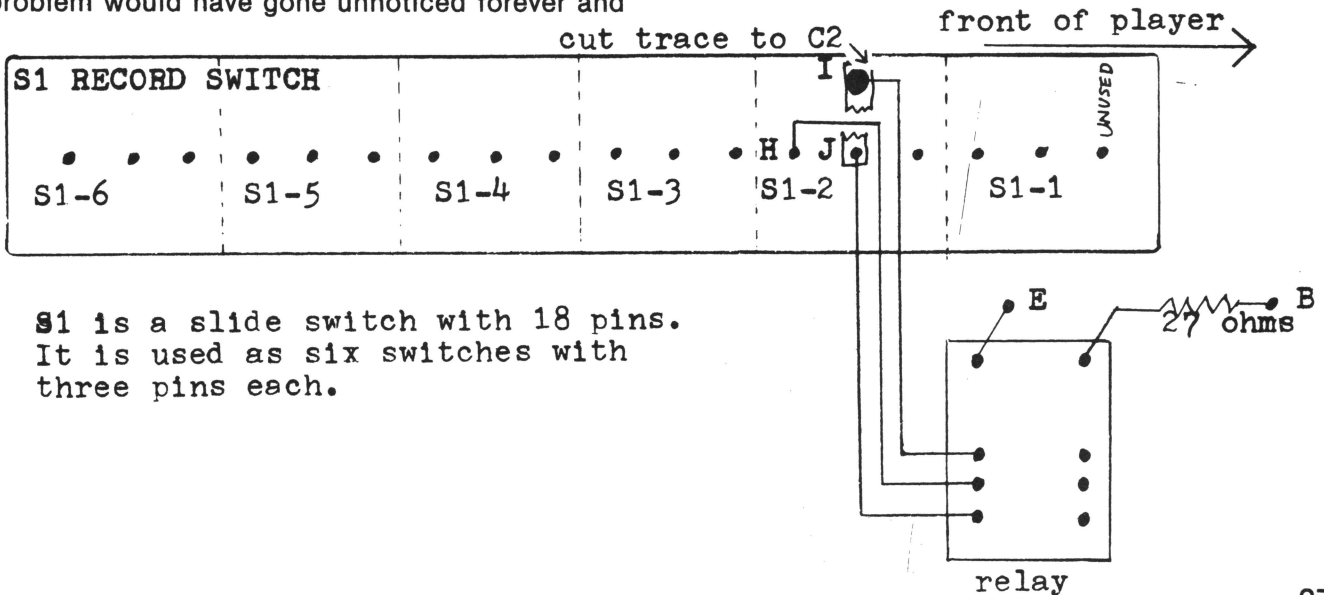

S1 is a slide switch with 18 pins. It is used as six switches with three pins each.

PRINTED CIRCUIT GROUND TRACE

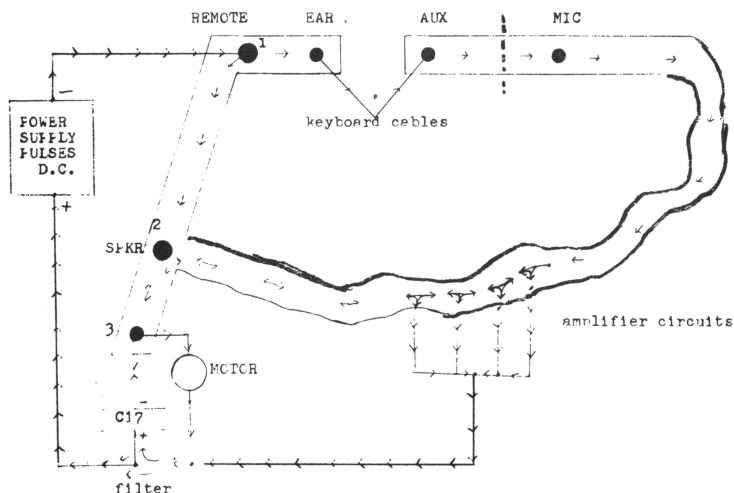

But now, yet another mystery. When I used my own switch for turning on the tape motor there was no hum. This meant that my circuit was working better than the original. But why? My solder connection (3) on the circuit board ground trace was less than two inches away from the original remote connection (1). See ground trace illustration. If placement of the connection for the input of the negative unfiltered power is critical, let's unsolder this REM connection (1) and move it down towards (3) just a little at a time to see what happens. As I kept touching the trace further along in either direction of the ground loop the hum remained until I reached the trace junction at the SPKR connection where it suddenly disappeared. What a simple solution this shows. Just make the REM (1) wire and the SPKR (2) wire switch places! It doesn't matter where the SPKR wire goes but this way no extra hole has to be drilled.

So - we have noise when the current is allowed to flow through the ground loop on its way to the filtering condenser and the motor. When the electrons are injected below the loop at the SPKR connection they try to flow two ways into a closed loop and can't move. The trace normally has a separation between the EAR and AUX connections; but the TRS-80 cables short this together allowing the unwanted current flow. Later I found out from the new local computer center that their way of solving this problem is to just cut the trace again to the right of the AUX connection and then solder a jumper wire from the EAR to AUX connections just in case the player is used with the cables unplugged. I then tried both ways and found absolutely no difference in performance between either method. And what an improvement either one of these modifications make! By CSAVEing my own tapes with this modification, I have never had a loading problem I can get a flawless CLOAD from a volume setting of anywhere from 2.5 to 7. I figured the midrange of these two settings and used a pin to paint a white line on the volume dial between two of the teeth. The only time it has to be readjusted is when you are using a tape that you didn't record yourself. Machine language tapes are the same way and can be very easily redone by using a special tape program such as DUPLIK, for example. I'm glad I didn't install the VU meter now.

PARTS LIST

- 1 CTR-41
- 4 Toggle switches SPDT Radio Shack #275-613 (or 3 SPST and 1 SPDT)
- 1 Relay #275-215
- 1 Low profile IC socket (optional) #276-1998
- 2 Condensers 22uf #272-1026 (for arc suppression on switches and motor brushes.)
- 1 1/4" black labelmaker/label for switches.
- 1 Resistor 100 ohm 1/2 watt #271-012 or 1/4 watt from kit #271-308
- 1 Resistor 27 ohm 1/2 watt #271-006

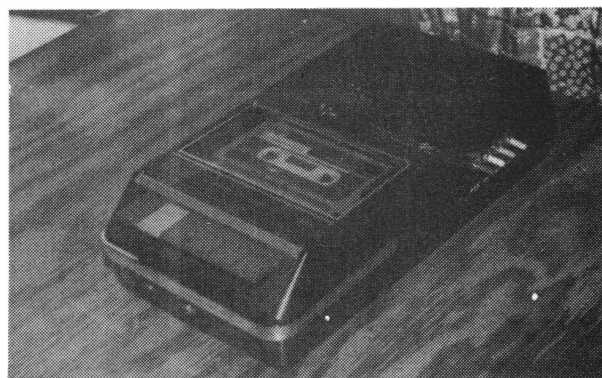

EXTRA INFORMATION

Cut trace between I and J as indicated by the slash mark on the schematic.

The slash mark between C and D on the schematic indicates that the black motor ground wire was unsoldered from the circuit board and reconnected to point D which is one side of the new condenser and also to a wire coming from the amplifier switch.

The 100 ohm resistor was soldered directly to the volume switch.

There are two unused slots in the circuit board edge near the transformer which are excellent for mounting the two 22uf condensers. The unused traces can even be used for this purpose.

To drill four holes for the switches, mark hole centers 11.25 mm from each other and 7mm below the ridge on your upside down recorder with the cover removed. The first hole is marked at least 77mm from the end of this ridge that is towards handle and front of recorder.

Remove all washers from these switches and just use one nut on each side of the hole. They should come out flush this way.

After assembly, the label is placed directly beneath the other ridge on the cover below switches.

Use recorder with tone switch set on HIGH.

Remember, it is a good idea to keep your keyboard clean but don't try to blow the chips out!

MAYDAY™

The Complete Uninterruptable Power Supply



The lights blinked - even the slightest power failure



can ruin a data disk and cause loss of the program.



Protect your time and investment -

easy to use -
just plug your computer into
MAYDAY.™



for more information contact ...

Sun - Technology, Inc.

Box 210

New Durham, New Hampshire 03855

(603) 859-7110

We honor:



(Manufacturing high technology products since 1970)

READER SERVICE 4

THE PHYSICIANS MICROCOMPUTER REPORT

Interesting Articles on
Microcomputer
Applications in:

- Medical Account Records
- Tax Record Preparation
- Automated Patient Billing
- Patient History Review
- Drug Inventory and Prescription Printing
- Employee Compensation
- Disease and Drug Cross-Indexing
- Success of Treatment Evaluation
- Lab Data Processing
- Access to Large Medical Data Bases (Toxicology)
- Third Party Billing
- Patient Scheduling
- Word Processing
- Continuing Medical Education
- Aids for the Handicapped
- Microcomputer Book Reviews
- Bio-Med Statistics
- MUMPS on Micros
- Investment Analysis
- Computer Games



The information contained in the Physicians Microcomputer Report could save you thousands of dollars and a lot of headaches.

The burgeoning costs of health care can only be controlled by the most efficient means of data acquisition, recording, and processing.

There is no doubt that microcomputer technology will touch every phase of medical practice.

In the Physicians Microcomputer Report you get objective analysis on:

- How to pick the microcomputer system that best suits your medical and professional needs.
- Where to find low cost medical and business software.
- Articles and programs written by physicians on microcomputer application in business, research, and their own specialties.
- News on the latest developments in medical electronics and microcomputer applications.
- Articles for the novice medical microcomputer user.
- National coordination of microcomputer medical software development and coverage of medical related computer conferences.
- No nonsense economic facts on whether now is the time for you to computerize or just add more personnel.
- Analysis of the future impact microcomputers will have on the allied medical areas.

Please start my Club Membership and Subscription to the *Physicians Microcomputer Report*.

A limited number of free sample copies are available if you hurry.

Name (Print) _____ Address _____

City _____ State _____ Zip _____

\$25 One year (12 issues) \$15 Special six month trial subscription

Bill Visa/BankAmericard Bill Master Charge \$12.50 Student Rate

Credit Card # _____ Interbank # _____ Expir. Date _____

Check enclosed for \$ _____

Send to: Dr. Gerald M. Orosz, Editor, *Physicians Microcomputer Report*,
Box 8483, Lawrenceville, N.J. 08648

S. S. S. S.

S-80 Specialized Software Sources

Our original idea was to publish a list of programs marketed directly by the author. However, since that time Radio Shack has decided to do exactly the same thing. Therefore, in the interest of fair play (we didn't want our book sales hindering their effort!), we have decided to let Radio Shack do it. The following submissions were received before we cancelled the project. If you are interested in any of the following programs, contact THE AUTHOR DIRECTLY.

COMPUTERIZED TYPING

Machine Language Level II 4K and up. For school papers, letters, etc. Upper/lower case printing, and display with mod and works without mod. Automatic wrap around of text on display and printing, right margin from 10-64 on the screen, 10-99 on printing. Has insert and delete any amount of text and text can be saved on cassette. Note: with 4K only about 1300 characters of text. \$14.05 for instruction, cassette, postage and handling. Please say if you want disk dumpable.

John R. Walker
5616 Silverleaf Road
San Jose, CA 95138

COMIC BOOK COLLECTION AND MAGAZINE INVENTORY SYSTEM

Supports comic book and magazine collections and store inventories. Including price lists, want lists, pricing labels, and collection value reports. Uses overstreet grading and pricing. Perfect for collection insurance purposes! \$99.95 on disk

Harry A. Hopkins
P.O. Box 873
Langley AFB, VA 23665

HANDICAPPED PROGRAMS

16K Level II. Thoroughbreds \$20, Pacers \$16, both \$30.00. O/P to screen or printer, many options, wagering tips. Complete system with user manual. Send check or self addressed stamped envelope for information.

Raymond J. Herold
8363 Shady Grove Cir.
Manassas, VA 22110

BILLING SYSTEM

Set up for small telephone answering service, can be

adapted to any business with a regular periodic charge for customers. Uses 2 cassette recorders. Five programs in binder, documented. 32K LII, EI, two recorders, printer \$100.

John Stedeford
c/o Telanswer
138 Second Street East
Twin Falls, ID 83301

HORIZONTAL MARQUEE

Message travels from left to right on screen. New message can be entered while old is displayed. 4K LII. \$5.00

John Stedeford
c/o Telanswer
138 Second Street East
Twin Falls, ID 83301

HEX TO DECIMAL DECIMAL TO HEX CONVERSION

Converts one or series of consecutive numbers at a time. 4K LII \$5.00.

John Stedeford
c/o Telanswer
138 Second Street East
Twin Falls, ID 83301.

HORSE RACE HANDICAPPER

A powerful handicapping program that generates a probabilistic regressive mod for each horse in a race. Best record for a single day 89%. For TRS-80 Level II 16K. \$14.95 check or money order.

Alfred Camisa
7615 Glenbrook Ct
Pleasanton, CA 94566

CONIFERS

User identifies unknown North American conifer species by answering questions about the trees characteristics. Over 45 trees are included on two 16K programs. (Level II) Cassette \$15. ESF Wafer \$17. Disk \$20.00. Postpaid. Send self addressed

stamped envelope for information.

Wynne Keller
RD 1 Box 507
Solon, ME 04979

GALACTIC BARRIER

Rajeev Jayavant and Robert W. Lord have created a fast, machine language "Breakout" type game for L II TRS-80. Program features load-and-go running and a subroutine to redirect the READY button. Through variations in paddle size and ball speed, 270 game variations may be played. Available on tape for \$5.95. Send requests to:

Robert W. Lord
P.O. 66
Burton, OH 44021

HONEYBOOK

A program written for commercial and hobby beekeepers. Written for 16K Level II system, all records are stored on tape files. Keeps production records, requeening schedules, and displays P&L's in an attractive line graph so you easily compare year to year production. Comes on cassette tape for only \$12.95. Written by an experienced apiarist who writes programs for a living.

Phillip Case
211 N. Ken
Springfield, MO 65802

CATTLE INVENTORY

Another fine record keeping program from Phillip Case. Available for both the TRS-80 and APPLE, this program keeps disk records of calving history, locations, origins, tag numbers, birthdates, descriptions, etc. Stored in random files, these programs make very efficient use of disk space. Apple version written for two drive Apple II plus system. Both versions require 32K or more memory. A complete system for only \$99.95.

Phillip Case
211 N. Ken
Springfield, MO, 65802

The Controller

ELECTRONIC SECURITY AND CONVENIENCE AT YOUR FINGERTIPS

BSR

SYSTEM X-10



ULTRA SONIC COMMAND CONSOLE . . . Its keyboard permits remote control operation of lights and appliances in up to 16 separate locations. (List \$49.95) . . . \$42.99

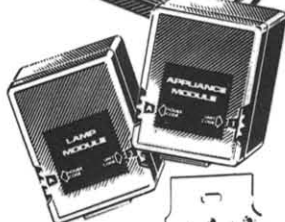

LAMP MODULE . . . Will control any incandescent lamp rated up to 300 watts from control signals received from Command Console. Functions include on and off, brighten and dim. (List \$16.99) . . . \$14.99

APPLIANCE MODULE . . . Receives signals from the Command Console to turn an appliance on and off (e.g.: TV, stereo, fan, etc.). (List \$16.99) . . . \$14.99

WALL SWITCH MODULE . . . Receives signals from the Command Console to control lights or lamps normally operated by a wall switch. (List \$16.99) . . . \$14.99

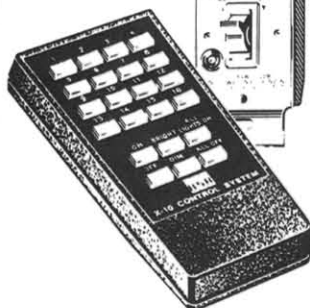

CORDLESS CONTROLLER . . . Transmits signals to the Ultra Sonic Command Console from any distance up to 30 feet. All functions of the Command Console are duplicated on the Cordless Controller. (List \$24.99) . . . \$19.99

BUSY BOX . . . Connects to your micro-computer and transmits signals to the Ultra Sonic Command Console from any distance up to 30 feet. Your computer can now be programmed to control all functions of the BSR X-10 Home Control System, including dimming of lights. This unit connects directly to your TRS-80 (List \$109.95) or APPLE (List \$114.95) . . . \$99.95
S-100 Busy Box (List \$119.95) . . . \$114.95

SPECIAL CONTROLLER STARTER KIT . . . Includes BSR X-10 Ultra Sonic Controller, 2 Lamp Modules, 1 Appliance Module, 1 Cordless Controller and Busy Box (specify for TRS-80 or APPLE). (List \$240.90) . . . \$199.95

TRS-80 4 YEAR HOME CONTROL PROGRAM . . . \$19.95

(Above prices do not include postage and handling)



6 SOUTH ST., MILFORD, NH 03055

To order: Call Toll-Free 1-800-258-1790 (in NH call (603) 673-5144)

The Software Exchange & HardSide (Div. of Robitaille & Sons, Enterprises, Inc.), SoftSide Publications



WHY?.....



spend all those \$\$\$'s on TRS-80 software? Each issue of The 80-U.S. JOURNAL contains a generous quantity of programs for your business or pleasure. This 100-page bi-monthly is entering its third year with some exciting things you can do with your computer! You won't believe the programs you can get for so little expense.

A current sample issue can be yours for only \$3.00 (first class postpaid), a one year subscription in the United States is only \$16.00. VISA/MC are accepted, call (206) 475-2219 or send check or MO TODAY to: 80-U.S. Journal, 3838 South Warner St., Tacoma, WA 98409.

TRS-80 is a trademark of the Tandy Corp.

READER SERVICE 3

THE S-EIGHTY™

A Softside Publication
Box 68, 6 South St., Milford, NH 03055

U.S. POSTAGE
PAID
—BULK RATE—
PERMIT NO. 21
MILFORD, NH 03055